

Installation instruction

Control Panel for Fire Ventilation

SVL 24V-15A / SVL 24V-20A / SVL 24V-32A / SVL 24V-40A /
SVL 24V-50A

SVL 48V-10A / SVL 48V-15A / SVL 48V-20A / SVL 48V-32A /
SVL 48V-50A



Fire ventilation

Comfort ventilation

24VDC/48VDC max. 10A/15A/20A/32A/40A/50A

2 - 6 actuator outputs

6 fire ventilation groups, 6 comfort groups

Connection for fire switches, wind- and rain sensor, comfort switches, smoke detectors

Possibility for bus connection of 10 SVL Control Panels

Address of installation

Name: _____

Address: _____

Phone no.: _____

Contact person: _____

Date of installation: _____

Installation

Number of SVL control panels and type (e.g. SVL 24V-20A): _____

Number of fire ventilation groups: _____

Type of opening system: _____

Type of opening system: _____

Type of opening system: _____

External controls (AFA-CTS): _____

Comfort control: _____

Wind- and rain sensor: _____

230V power supply from group: _____

Table of contents

Address of installation / Description of installation2
 General description4
 Safety rules during installation and operation5
 Explosion danger5
 Installation.....5
 Yearly legal requirement of maintenance and control (authorized).....5
 Connection to motor- (actuator-) outputs and line monitoring6
 Connection to motor- (actuator-) outputs and line monitoring6
 Connection of iMCP/iFPS in ring connection7
 Connection of more controls to one fire group (CCPB)7
 Connection of smoke-/heat detectors8
 Connection of comfort switch.....8
 Connection of weather sensor9
 Connection of smoke-/heat detectors and comfort switch in iMCP/iFPS9
Diagram SVL control panel and connections10-11
 SVL Group installation12
 Diagram SVL Group13
 External LEDs on front panel (LED board).....14
 Internal LED indication on main board15
 Fuse specifications16
 Cable sizes16
 Part numbers and accessories.....18
 Declaration of Performance19
 Technical specifications20

Rev 0.03 09.01.2023

NEW control and setup functions in our app "SVL"

DOWNLOAD HERE

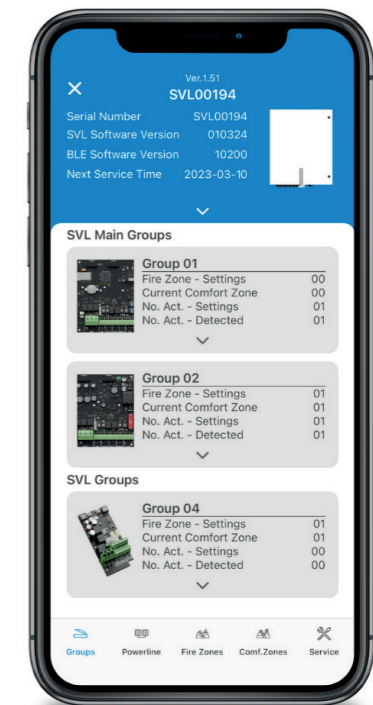

Manufacturer:

Actulux A/S
 Porsborgparken 35
 DK 9530 Stoevring
 Denmark

Tel.: +45 98 57 40 90
 e-mail: info@actulux.com
 www.actulux.com

General description

The SVL control panel can be used for electrical opening of e.g. skylights, smoke hatches or similar in connection with fire- and comfort ventilation.

The SVL control panel has different inputs with line monitoring which can be activated by e.g. fire switches, smoke detectors, heat detectors, AFA systems and CTS systems. For control of the indoor climate (comfort ventilation) manual switches, weekly timer, room thermostat and outdoor weather sensors can be connected.

By means of LEDs in the front panel the control indicates the operating condition (ok operation and error- and alarm condition), just as it by means of the built-in potential free relay contacts can relay operating information about ok operation and error- and alarm condition to other systems in the building.

The SVL control panel is a part of a range of control panels which are all built with a AC main supply and with either 24 or 48 volts DC motor supply. The range consists of the following types:

SVL 24V-15A / SVL 24V-20A / SVL 24V-32A / SVL 24V-40A / SVL 24V-50A
24 volts DC motor supply, power capacity 15A, 20A, 32A, 40A and 50A respectively.

SVL 48V-10A / SVL 48V-15A / SVL 48V-20A / SVL 48V-32A / SVL 48V-50A
48 volts DC motor supply, power capacity 10A, 15A, 20A, 32A and 50A respectively.

The polarity of the motor supply is reversed when opening or closing. The SVL control panel has built-in 72 hours battery backup. (May be less if battery backup is chosen for wind and rain sensor, or other devices there are connected to terminals 25 and 26.)

By a CAN bus system consisting of a 2 wire cable the SVL control panels can be mutually connected so that up to 10 SVL control panels can be connected in a loop and operate as an integrated system.

Connection of cables to the in- and outputs of the SVL control panel is described in the connection drawing on page 10-11.

A more detailed connection to the individual in- and outputs is described in the individual sections in this manual.

Selection of cable sizes on page 16-17.

Examples of types of opening systems and the max. power consumption which can be connected to the SVL control panel:

Type:	24V power supply:	48V power supply:
SA Power Single	4A	2A
SA Power Double	8A (2x4A)	4A (2x2A)
SA Power Large	8A	4A
SA Power Mini	2,5A	1,25A
Others	See specification of max. power consumption on the opening system	

Safety rules during installation and operation

The SVL control panel may only be installed and maintained by personnel authorized for installation of automatic electrical fire ventilation equipment.

Explosion danger

The SVL control panel is supplied with back-up batteries, which contain large amounts of energy which can be released as explosion in case of wrong handling - the following safety rules must therefore always be observed:

- Never short-circuit a back-up battery.
- Do not use external chargers on installed batteries. If unauthorized chargers are used explosive gasses can be released from the battery.
- Do not drop back-up batteries as strong acids can be released if they are broken.

Installation

The SVL control panel can weigh up to 48 kgs and must be installed on a stable wall. The wall fitting placed on top of the back of the control panel should be loosened from the control panel and placed on the wall.

The lower fitting on the back of the control panel should be turned downwards and the control panel should be hanged on the wall fitting. After this the lower fitting should be fastened to the wall. All cables are connected according to the drawing on the central pages and are dimensioned according to table page 16.

If cables are passed through the back plate, the edges of the plate must be lined with edge bands to protect the cables.

Keep in mind that the operating voltage from the SVL control panel is either 24V or 48V and that the max. voltage drop is 15% which demands correct cable dimension.

Please be aware that it often may be required (in order to keep the demands on the CE marking of the complete installation or another law) that the SVL control panel is supplied with 230VAC from separate powerline with its own residual current relay, and that a repair interrupter is mounted on the motor lines. Optional: The padlock bracket #212150 may be used - please consult with local laws.

After connection the SVL control panel must charge the batteries min. 12 hours before complete testing.

Yearly legal requirement of maintenance and control (authorized)

The functions of the SVL control panel and the opening system must be tested by authorized personnel at least once a year. The SVL control panel informs when the maintenance should be done. The external LEDs on the front panel are running fast. The SVL control panel and opening system are of course still full operating. Please call a service technician at your earliest convenience in order to carry out the maintenance and to test the control and opening system, in order to prepare it for another year of operation. The legal requirements for this must be observed and the testing and control must as a minimum include the following:

- Control that all opening systems move to full opening when the fire function is activated - should not be carried out if the wind is more than 6 m/sec. as there might be a risk that the opening system cannot close automatically.
- Control of the batteries. If the batteries are replaced it is important to use the same type, as the batteries are carefully chosen to be able to deliver the current, for which the control is specified.
- Control of in- and outputs on the control panel.
- Control of fire switches and smoke- and heat detectors.

The batteries should be replaced as required, however at least every third year!
Use the same brand.

Connection to motor- (actuator-) outputs and line monitoring

Ex. SA Power Single

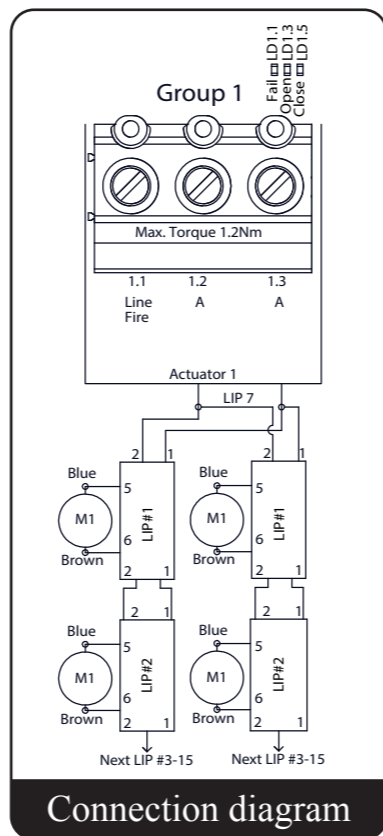
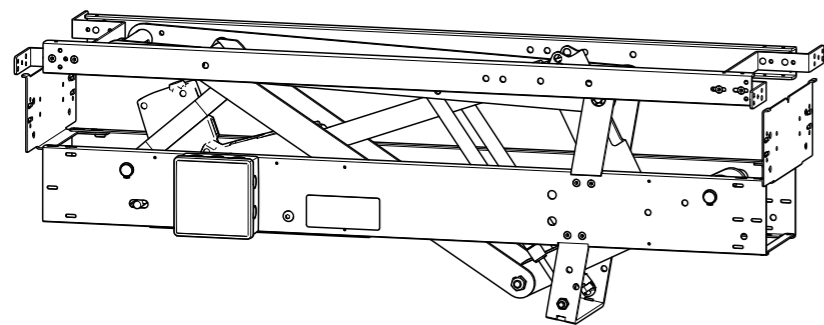

Connection of iMCP/iFPS in ring connection

Ex. iMCP

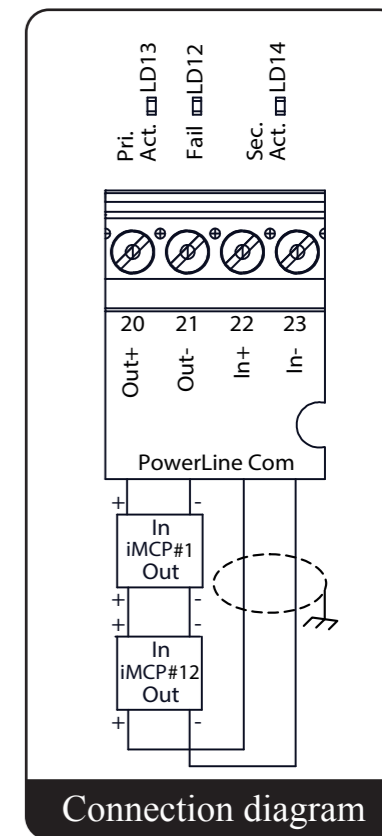
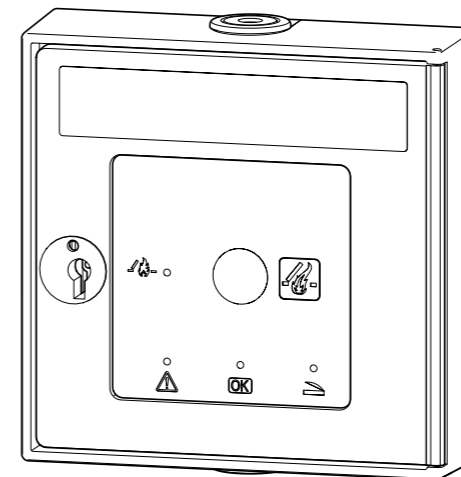

Connection to motor- (actuator-) outputs and line monitoring

Ex. HCV

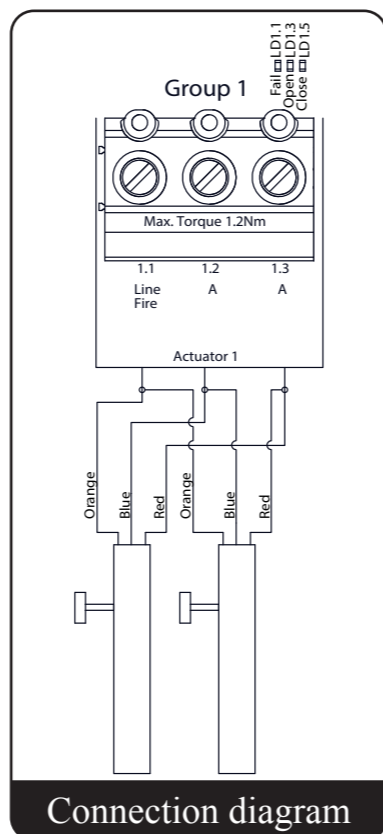
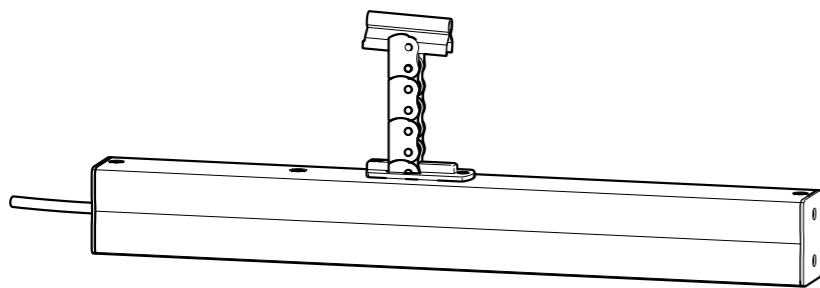

Connection of more controls to one fire group (CCPB)

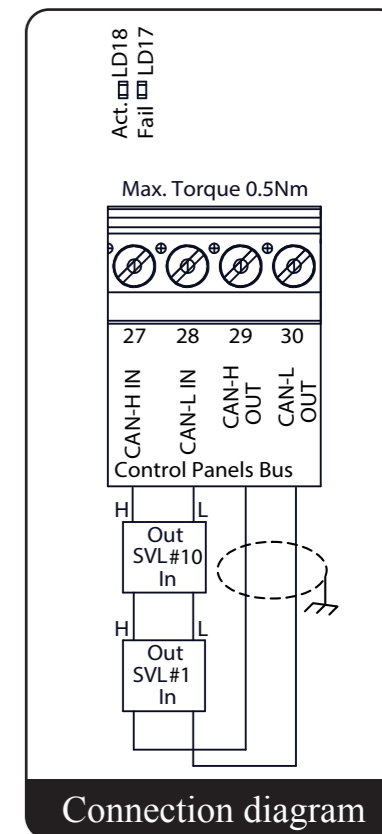
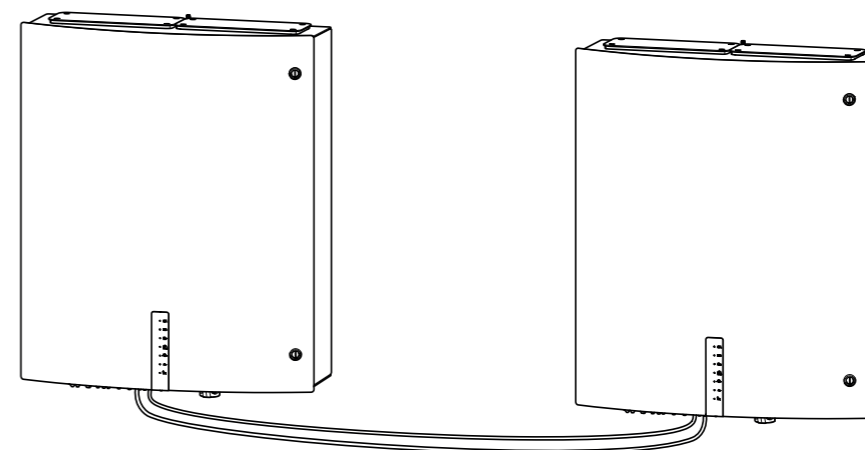

Connection of smoke-/heat detectors

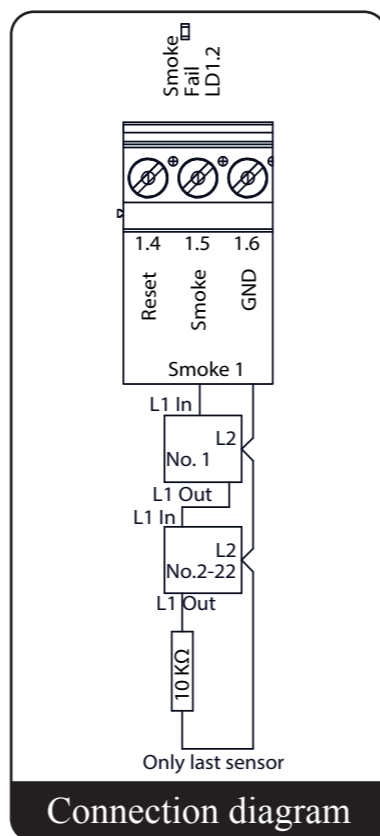
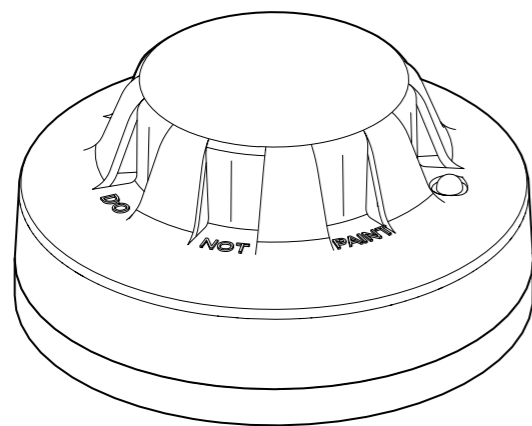

Connection of weather sensor

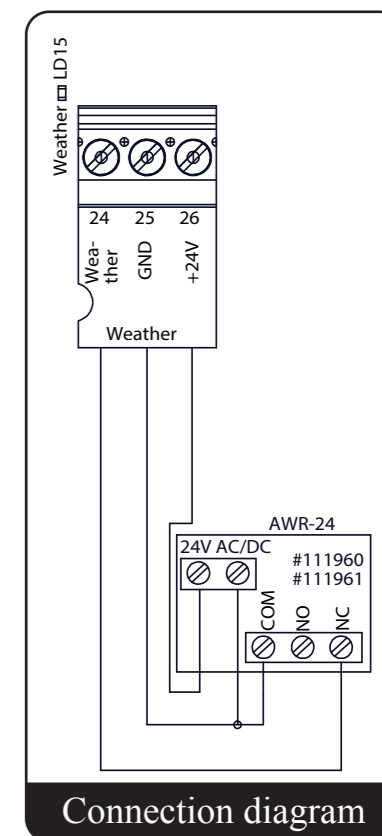
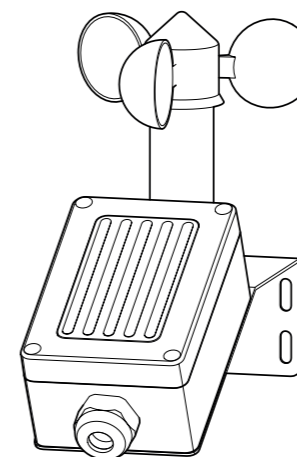

Connection of comfort switch

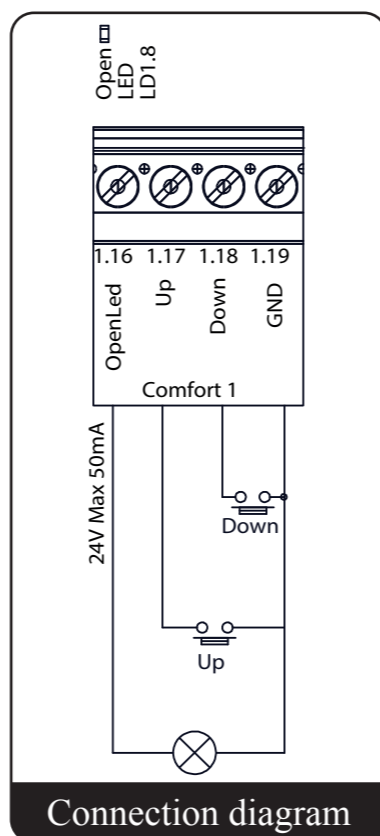
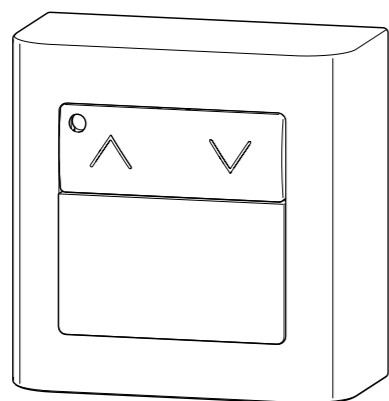

Connection of smoke-/heat detectors and comfort switch in iMCP/iFPS

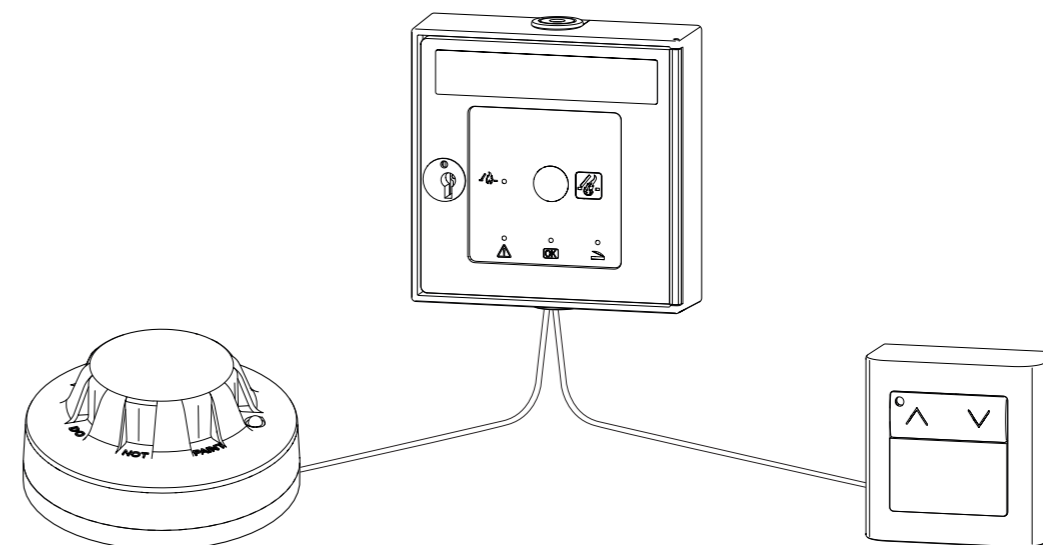

SVL Group installation

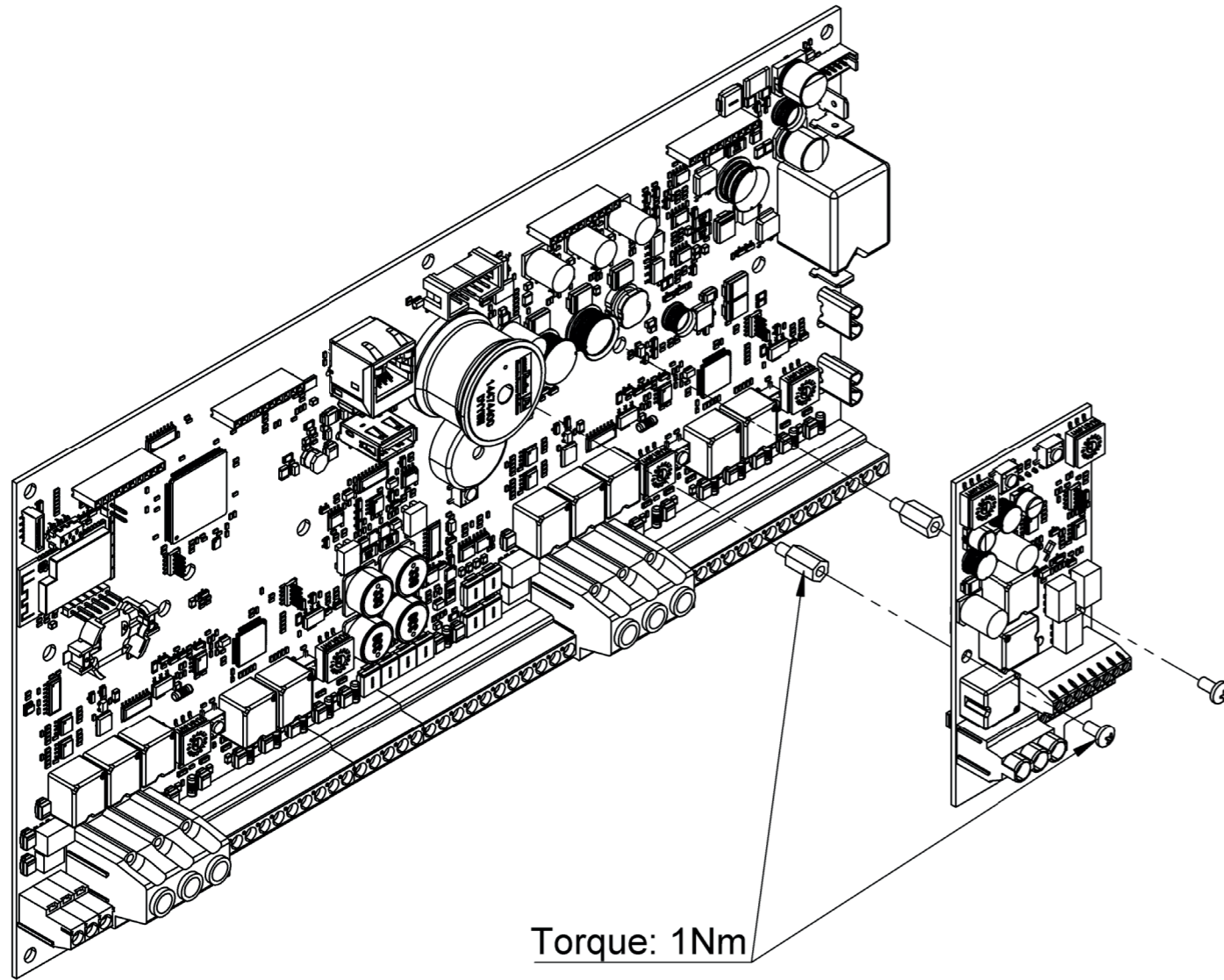

Torque: 1Nm





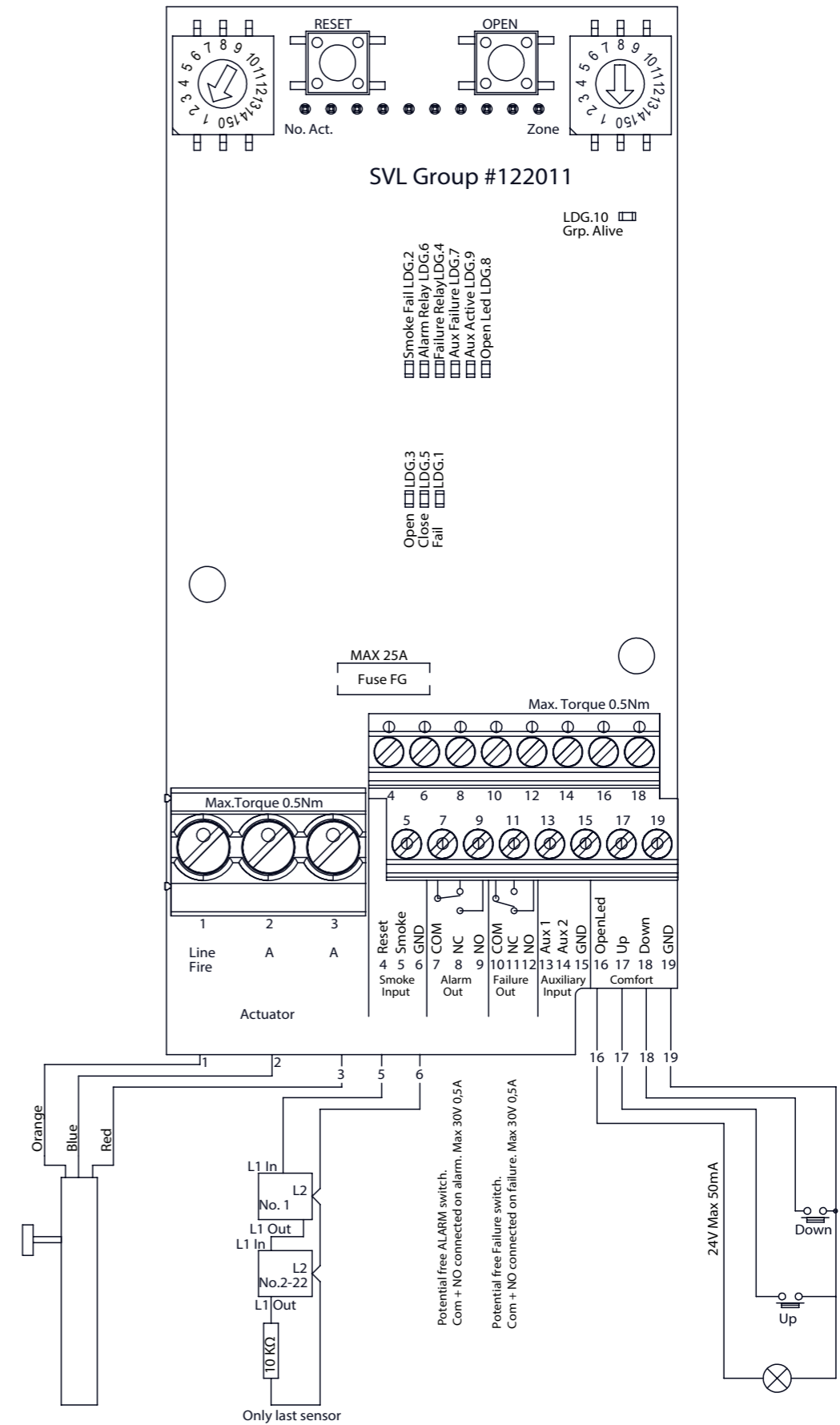



WARNING! Turn off power before installation

Diagram SVL Group



Connection Diagram SVL Group
Drawing: 211990-

External LEDs on front panel (LED board)

		Operation possibilities for:	Alarm/fire	Comfort operation
Indicator on front	Colour	Meaning: Switched off - lights - flashes		
	Green	lights if everything is ok switched off by local error on this control panel flashes by error message from other control panels received by bus	Yes	Yes
	Yellow	flashes by local battery error on this control panel or by error message from other control panels received by bus	Yes	Yes
	Yellow	flashes by local error on this control panel or by error message from other control panels received by bus	Yes	Only close
	Yellow	flashes by local error on this control panel or by error message from other control panels received by bus	Yes	Only close
	Red	lights red constantly on the active control panel receiving signal flashes during alarm via bus	Yes	No
	Blue	lights blue when any of the groups are open	Yes	Yes
	Amber	lights amber constantly when weather signal is on. When signal is on opening of outputs is not possible.	Yes	No
	All lights	running lights time for yearly service - please call for supplier	Yes	Yes

Internal LED indication on main board

		Operation possibilities for:	Alarm/fire	Comfort operation
Group	LDG.1	Line error on actuator (yellow). Lights when actuator has open circuit. Flashes at earth fail or when short circuit occur. If flashing, it is not possible to RESET or close actuator output	Yes	Only close
	LDG.3	Actuator open (red). Lights when actuator opens	Yes	Yes
	LDG.5	Actuator close (green). Lights when actuator closes	Yes	Yes
	LDG.2	Line error on smoke detector (amber). Lights when smoke detector has line error. Flashes when shorted circuit occur	Yes	Only close
	LDG.6	Alarm relay Active (red)	Yes	No
	LDG.4	Fail relay Active (amber)	Yes	-
	LDG.9	Aux Active (blue)	Yes	Yes
	LDG.7	Aux Failure (amber)	Yes	Yes
	LDG.8	Lights blue constantly in open condition (when windows are open). Flashes when actuator is moving up or down	Yes	Yes
	LDG.10	Alive led from group processor (white)	Yes	Yes
Main	LD13	Primary supply on Powerline to iMCP active (green)	Yes	Yes
	LD12	Fail on Powerline to iMCP (amber)	Yes	Yes
	LD14	Secondary supply on Powerline to iMCP active (green)	Yes	Yes
	LD16	+24V active on Terminal 26 (amber)	Yes	Yes
	LD15	Weather sensor active (amber). Lights when weather sensor is active	Yes	Only close
	LD17	BUS error (amber). Lights when BUS signal from other control panels is missing or loop wire in terminals are missing	Yes	Only close
	LD18	Bus activity to other control panels (green)	Yes	Yes
	LD5	Alive led from main processor (white)	Yes	Yes
LD11	A Bluetooth connection to the central is active (white)	Yes	Yes	
		When the front door is closed all LEDs are shut off	Yes	Yes

Fuse specifications

Fuse value	Placement	24V/48V
F1 50A/80V MAXI		Main DC input fuse
F2...7 25A/80V ATO0		Output fuse for each group
F8 16A		Main AC fuse

Cable sizes

It is very important to use the correct cable types and sizes to make sure that the fire ventilation system meets the standards and works correct in an emergency.

The two most important factors are the ability of the cables to resist heat and to make sure that the voltage drop in the cables to the actuators do not exceed 15% at full load on the fire ventilation hatches.

Fire resistant cables according to IEC 60331 must be used for the following functions:

Opening systems with actuators 24/48V	2 wires, see diagrammed (3 wires by external line surveillance)	Max. cable length
iMCP/iFPS 24V	Min. 2 x 0,5 mm ² shielded (0,8 mm)	300 m in total
Smoke detector 24V	Min. 2 x 0,5 mm ² (0,8 mm)	100 m*
Heat detector	Min. 2 x 0,5 mm ² (0,8 mm)	100 m*
Bus cable	2 x 0,5 mm ² shielded (0,8 mm)	500 m

* For cable lengths longer than 100 m, properly closed shielded cables must be used.

Normal cables can be used for the following functions:

Supply for control 230VAC	e.g. 3 x 1,5 mm ²
Comfort ventilation button 24V	Min. 4 x 0,5 mm ²
Wind- and rain sensor 24 V	Min. 3 x 0,5 mm ²

Table for SVL 24V-XX allowable voltage drop 15% = 3,6V

Power consumption per group in ampere	Cable cross section and amount of cores						
	2x1,5 mm ²	2x2,5 mm ²	4x1,5 mm ² (2x1,5+2x1,5)	4x2,5 mm ² (2x2,5+2x2,5)	2x6 mm ²	5x2,5 mm ² (2x2,5+3x2,5)	2x10 mm ²
2	74 m	123 m	148 m	246 m	295 m	307 m	492 m
4	37 m	61 m	74 m	122 m	148 m	154 m	244 m
6	25 m	41 m	50 m	82 m	98 m	102 m	164 m
8	18 m	31 m	36 m	62 m	74 m	77 m	124 m
10	15 m	25 m	30 m	50 m	59 m	61 m	100 m
12	12 m	20 m	24 m	40 m	49 m	51 m	80 m
14		18 m	22 m	36 m	42 m	44 m	72 m
16		15 m	18 m	30 m	36 m	38 m	60 m
20		12 m	15 m	25 m	30 m	31 m	49 m
25			12 m	20 m	24 m	25 m	39 m

Table for SVL 48V-XX allowable voltage drop 15% = 7,2V

Power consumption per group in ampere	Cable cross section and amount of cores						
	2x1,5 mm ²	2x2,5 mm ²	4x1,5 mm ² (2x1,5+2x1,5)	4x2,5 mm ² (2x2,5+2x2,5)	2x6 mm ²	5x2,5 mm ² (2x2,5+3x2,5)	2x10 mm ²
2	148 m	246 m	295 m	492 m	590 m	615 m	984 m
4	74 m	123 m	148 m	246 m	295 m	307 m	492 m
6	49 m	82 m	98 m	164 m	197 m	205 m	328 m
8	37 m	61 m	74 m	123 m	148 m	154 m	246 m
10	30 m	49 m	60 m	98 m	118 m	123 m	197 m
12	25 m	41 m	50 m	82 m	98 m	102 m	164 m
14	21 m	35 m	42 m	70 m	84 m	88 m	141 m
16	18 m	31 m	36 m	62 m	74 m	77 m	123 m
20	15 m	25 m	30 m	49 m	59 m	61 m	98 m
25	12 m	20 m	24 m	39 m	47 m	49 m	79 m

Part numbers and accessories

Part no.	Name of part	Description
122010	SVL Main board	Main board for 24/48V control panel
22801001	SVL Group board	Group board for extra motor output
211110	Power supply 350W 24VDC	Power supply for SVL24-15A
211111	Power supply 500W 24VDC	Power supply for SVL24-20A
211112	Power supply 750W 24VDC	Power supply for SVL24-32A
211113	Power supply 1000W 24VDC	Power supply for SVL24-40A
211114	Power supply 1500W 24VDC	Power supply for SVL24-50A
211121	Power supply 500W 48VDC	Power supply for SVL48-10A
211122	Power supply 750W 48VDC	Power supply for SVL48-15A
211123	Power supply 1000W 48VDC	Power supply for SVL48-20A
211124	Power supply 1500W 48VDC	Power supply for SVL48-32A
211125	Power supply 2500W 48VDC	Power supply for SVL48-50A
800622	Battery 12V/12Ah 151x94x98mm	Battery for SVL24-15A – 20A and SVL48-10A - 32A panels
800628	Battery 12V/18Ah 165x181x77mm	Battery for SVL24-32A – 50A and SVL48-50A panels
511890	iMCP Primary Smoke and Comfort IP30	Orange Fire switch for SVL Power line IP 30
511990	iMCP Secondary IP30	Orange Fire switch for SVL Power line IP 30
511940	iFPS Primary Smoke and Comfort IP30	Orange Fireman's Priority Switch for SVL Power line IP 30
511960	iFPS Secondary IP30	Orange Fireman's Priority Switch for SVL Power line IP 30
111629	Replacement glass for iMCP/iFPS	Replacement glass for fire switch
111702	Key for iMCP/iFPS	Key for fire switch for operation without breaking glass
111960	Rain sensor 250VAC / 24VDC	Rain sensor closes everything when raining
111961	Wind and rain sensor 250VAC / 24DC	Wind- and rain sensor closes everything when raining or strong wind
111735	Heat detector+base 75 degrees	Heat detector 75 degrees temperature activation
111741	Heat detector+base 90 degrees	Heat detector 90 degrees temperature activation
111740	Smoke detector, optical	Optical smoke detector
111742	Smoke detector, Ion detector	Ion smoke detector for invisible smoke
111943	Comfort Switch, 1 zone w/blue LED	Comfort switch with 1 zone Open indication
111944	Comfort Switch, 2 zone w/blue LED	Comfort switch with 2 zone Open indication
111760	Weekly timer 1 channel	Weekly timer, can e.g. close everything in the evening
111767	AUTO MAN switch OPUS with housing	Switch Auto. man. OPUS white, activates room thermostat or weekly timer
111770	Room thermostat RTR with resistor	Room thermostat for control of comfort ventilation
212095	Multigate MC25/27 Black	Multigate cable entry
212096	Blindplate FL21 Black	
212085	Antenna SVL top	
212150	Padlock Bracket	Safety lock for SVL chassis
911826	F8 Main fuse 16A 6,3x32mm	
99100905	F2-7 Group fuse 25A/80V	
99100908	F1 Main DC fuse 50A/80V	



(DK) YDEEVNEDEKLARATION IHT. FORORDNING NR. (EU) 305/2011)
 (UK) DECLARATION OF PERFORMANCE ACCORDING TO REGULATION NO. (EU) 305/2011)
 (D) LEISTUNGSEKLRÄRUNG GEMÄSS DER VERORDNUNG NR. (EU) 305/2011)
 (F) DECLARATION DES PERFORMANCES SELON RÈGLEMENT UE 305/2011



EN 12101-10:2005 BS EN 12101-10:2005

Produkt: Product: Produkt: Produit:	Strømforsyning Power Supply Stromversorgung Source de courant
Type/Type/Typ/Type:	SVM 24V-5A, SVM EI 24V-5A, DFM 24V-5A SVM 24V-8A, SVM EI 24V-8A, DFM 24V-8A SV 24V-8A, 24V-24A, 24V-30A, 24V-32A SV 48V/8A, 48V-24A, 48V-30A, 48V-32A SVL 24V-15A, 24V-20A, 24V-32A, 24V-40A, 24V-50A SVL 48V-10A, 48V-15A, 48V-20A, 48V-32A, 48V-50A
Formål: Purpose: Verwendungszweck: Description du produit:	Strømforsyning til aktuator brugt i forbindelse med brandventilation Power supply for actuators used for SHEV Stromversorgung für Antriebe, die für Rauchabzug genutzt werden Asservissement pour vérins électriques
Producenten/ Manufacture/ Hersteller Usine de fabrication:	Actulux A/S, Porsborgparken 35, 9530 Stoevring, Denmark
System for attesting og kontrol af ydeevne: System for attestation and verification of performance: System zur Bescheinigung und Prüfung der Performance: Système(s) d'évaluation et de vérification de la constance des performances du produit:	SYSTEM 1

<p>Det bemyndigede organ 0402 RISE Research Institute of Sweden udførte den indledende inspektion af fabrikken og af dennes egen produktionskontrol samt løbende overvågning, vurdering og evaluering af fabrikens egen produktionskontrol til SYSTEM 1 og følgende vises:</p> <p>The notified body 0402 RISE Research Institute of Sweden made the initial inspection of factory and of factory production control, and ongoing monitoring, assessment and evaluation of factory production control to the SYSTEM 1 and the following is displayed:</p> <p>Die notifizierte Stelle 0402 RISE Research Institute of Sweden hat die Erstinspektion des Werkes und der werks-eigenen Produktionskontrolle sowie die laufenden Überwachung, Bewertung und Evaluierung der werkseigenen Produktionskontrolle nach dem SYSTEM 1 vorgenommen und Folgendes ausgestellt:</p> <p>L'organisme notifié RISE (Research Institute of Sweden) 0402 a procédé à l'inspection initiale de l'usine et à son propre contrôle de production, ainsi qu'à la surveillance, à l'appréciation et à l'évaluation continues du contrôle de production propre à l'usine pour SYSTEM 1. Les éléments suivants sont indiqués:</p>	<p>CERTIFICATE OF CONSTANCY OF PERFORMANCE NO. 0402 – CPR – SC0354-13</p>
<p>Det bemyndigede organ BSI udførte den indledende inspektion af fabrikken og af dennes egen produktionskontrol samt løbende overvågning, vurdering og evaluering af fabrikens egen produktionskontrol til SYSTEM 1 og følgende vises:</p> <p>The notified body BSI made the initial inspection of factory and of factory production control, and ongoing monitoring, assessment and evaluation of factory production control to the SYSTEM 1 and the following is displayed:</p> <p>Die notifizierte Stelle BSI hat die Erstinspektion des Werkes und der werks-eigenen Produktionskontrolle sowie die laufenden Überwachung, Bewertung und Evaluierung der werkseigenen Produktionskontrolle nach dem SYSTEM 1 vorgenommen und Folgendes ausgestellt:</p> <p>L'organisme notifié BSI a procédé à l'inspection initiale de l'usine et à son propre contrôle de production, ainsi qu'à la surveillance, à l'appréciation et à l'évaluation continues du contrôle de production propre à l'usine pour SYSTEM 1. Les éléments suivants sont indiqués:</p>	<p>CERTIFICATE OF CONSTANCY OF PERFORMANCE NO. 0086 CPR 760202</p>

Ydeevnen af produktet i overensstemmelse med punkt 1 og 2 svarer til den deklarerede ydeevne for punkt 9.
 Ansvarlig for udfærdigelse af denne ydeevnedeklaration er producenten der er henvist til i punkt 4.
 Underskrevet på vegne af fabrikanten og navnet på fabrikanten af:

The performance of the product in accordance with point 1 and 2 corresponds to the declared performance for point 9.
 Responsible for creating this declaration of performance is only the manufacturer referred to point 4.
 Signed on behalf of the manufacturer and the name of the manufacturer of:

Die Leistung des Produkts gemäß den Punkt 1 und 2 entspricht der erklärten Leistung nach Punkt 9.
 Verantwortlich für die Erstellung dieser Leistungserklärung ist allein der Hersteller gemäß Punkt 4.
 Unterzeichnet für den Hersteller und im Namen des Herstellers von:

Les performances du produit identifiées aux points §1 et §2 sont conformes aux performances déclarées indiquées au point §9.
 La présente déclaration des performances est établie sous la seule responsabilité du fabricant identifié au point §4.
 Signé au nom du fabricant et nom du fabricant de:

Stoevring 2 January 2023, Jens Buus, Managing Director

Specifications	SVL 24V-xx Control Panels 24V-15A /24V-20A /24V-32A /24V-40A /24V-50A	SVL 48V-xx Control Panels 48V-10A /48V-15A /48V-20A /48V-32A /48V-50A
Note / Approvals / Conforms	"EN12101-10:2005 approved / certified - class A (double supply) - envir. class 1 (to -5°C) // Conform prEN12101-9	
Power supply	230VAC ±15% / max. 8A min 10 amp net fuse	230VAC ±15% / max. 14A. min 13 amp net fuse for 10-32 amp. panels and 16 Amp. for 50 Amp panels.
Output supply	24VDC	48VDC
Motor outputs	2 - 6 pcs. (line detecton: 0-15 lines)	2 - 6 pcs. (line detecton: 0-15 lines)
Max. total load	15A / 20A / 32A / 40A / 50A	10A / 15A / 20A / 32A / 50 A
Max. load each motor output	25A	25A
Operation temperature	-15°C to +40°C	-15°C to +40°C
Density	IP 54	IP 54
Battery back-up (72h)	Yes	Yes
Batteries	15A-20A = 2 pcs. 12V/12Ah 32A-50A = 2 pcs. 12V/18Ah	10A-32A = 4 pcs. 12V/12Ah 40A-50A = 4 pcs. 12V/18Ah
Dimensions (WxDxH)	516 x 215 x 660 mm	516 x 215 x 660 mm
Weight incl. batteries	Max. 34 kgs	Max. 48 kgs
Colour	White front / Black chassis	White front / Black chassis
Fire groups	1 -15 pcs. (by rotary switch) with line detect. / Max. power consumption for fire switches (LED + buzzer) =56mA= approx. 12 iMCP's	
Comfort groups	1 pcs. per motor output with open indication (Max 50 mA) - Unlimited number of mechanical comfort switches	
Detector (smoke/heat) input	2-6 lines max. 44 pcs. per panel / Max. power consumption 2.2 mA per line. Trigger point 15 mA	
Weather sensor input / close all	Yes	Yes
Alarm output	Yes - potential free contact, max. 48V / 0.5A	Yes - potential free contact, max. 48V / 0.5A
Failure output	Yes - potential free contact, max. 48V / 0.5A	Yes - potential free contact, max. 48V / 0.5A
24VDC for external use	24VDC / max. 0.5A - at 230VAC operation	24VDC / max. 0.5A - at 230VAC operation
Bus communication	Yes - connection of 2-10 control panels - line detection	
Visual (LED) indication in front panel	"OK" / "AC fault" / "Low battery" / "Line fault" / "Alarm" / "Open" / "Weather"	
Low Voltage Directive	2014/35/EU EN 61558-1:2006 (2nd edition), EN 61558-2-6, EN 61558-2-16 and EN 60335-1:2012 (4th edition)	
EMC Directive	(2014/30/EU)	EN50130-4:2011

Note for EN12101-10 approved editions

Type	Primary supply	Secondary supply	Interruption time
24V editions	23-26VDC, ripple 1V p/p	20-27VDC, max. load 50A	Less than 1.5 sec.
48V editions	48-51VDC, ripple 1V p/p	40-52VDC, max. load 50A	Less than 1.5 sec.

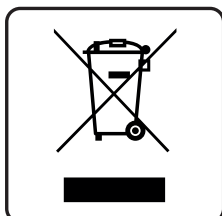

Electrical equipment, accessories and packaging must be sent for recycling for the protection of our environment!

Do not dispose electrical equipment with household waste!

According to European Guideline 2002/96 / EC on electrical waste, this must be disposed separately and sent for recycling to protect our environment.

13/03/2025

Manufacturer:

Actulux A/S
Porsborgparken 35
DK 9530 Stoevring
Denmark

Tel.: +45 98 57 40 90
e-mail: info@actulux.com
www.actulux.com