

LED Streetlight G2

Item Code	CCT	kg
705000021000	3000K	1.27kg
705000021100	3000K	1.27kg
705000021200	3000K	1.27kg
705000021500	4000K	1.27kg
705000021600	4000K	1.27kg
705000021700	4000K	1.27kg
705000022000	4000K	1.32kg
705000022100	4000K	1.32kg
705000022200	4000K	1.32kg

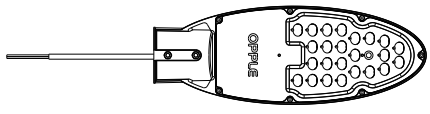

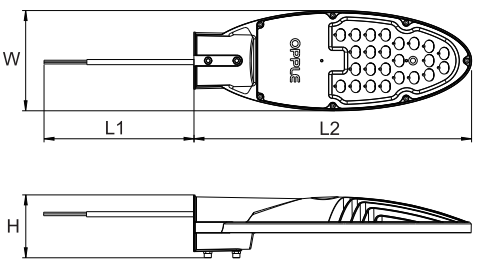

Model	L1 (mm)	L2 (mm)	W (mm)	H (mm)	MPA (m ²)
LED SL-E2 20W	1000	389	140	88	0.04
LED SL-E2 40W	1000	389	140	88	0.04
LED SL-E2 60W	1000	389	140	88	0.04

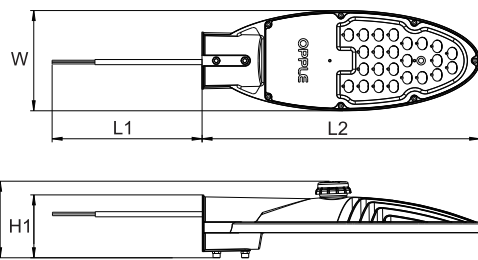

Model	L1 (mm)	L2 (mm)	W (mm)	H1 (mm)	H2 (mm)	MPA (m ²)
LED SL-E2 20W DD	1000	389	140	88	107	0.04
LED SL-E2 40W DD	1000	389	140	88	107	0.04
LED SL-E2 60W DD	1000	389	140	88	107	0.04

*MPA: Maximum Projected Area of the floodlight

ON/OFF version

- ① Additional IP66 waterproof connection box (NOT included in packaging) is necessary for power connection to ensure the waterproof performance and safety. The connection box and terminal block in it should conform to EN60598-2-1 or EN 60598-2-2 (Purchase separately).

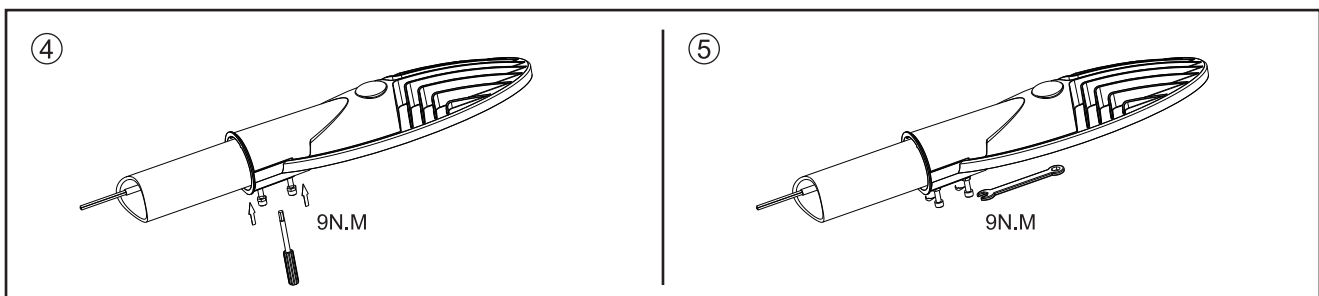
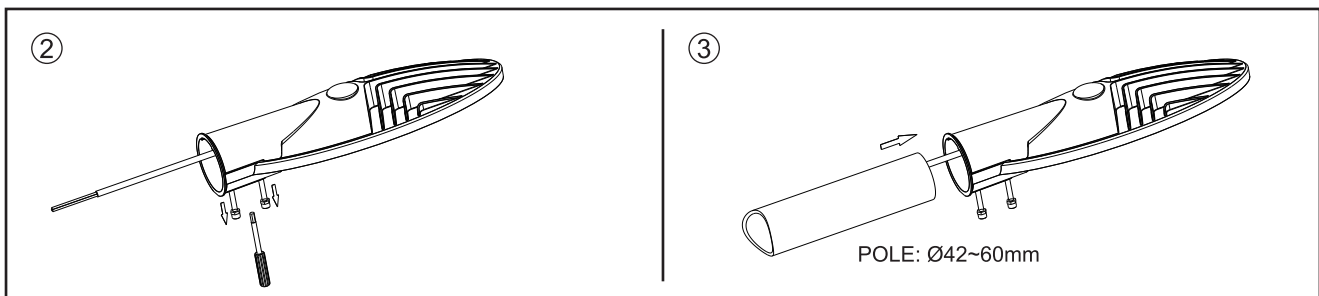
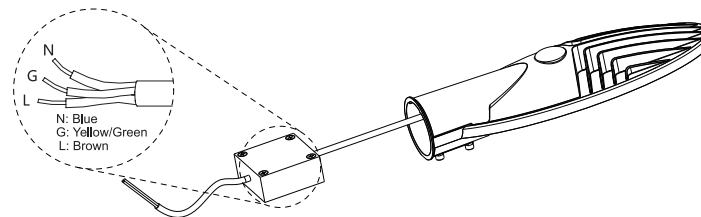

Daylight Detection version

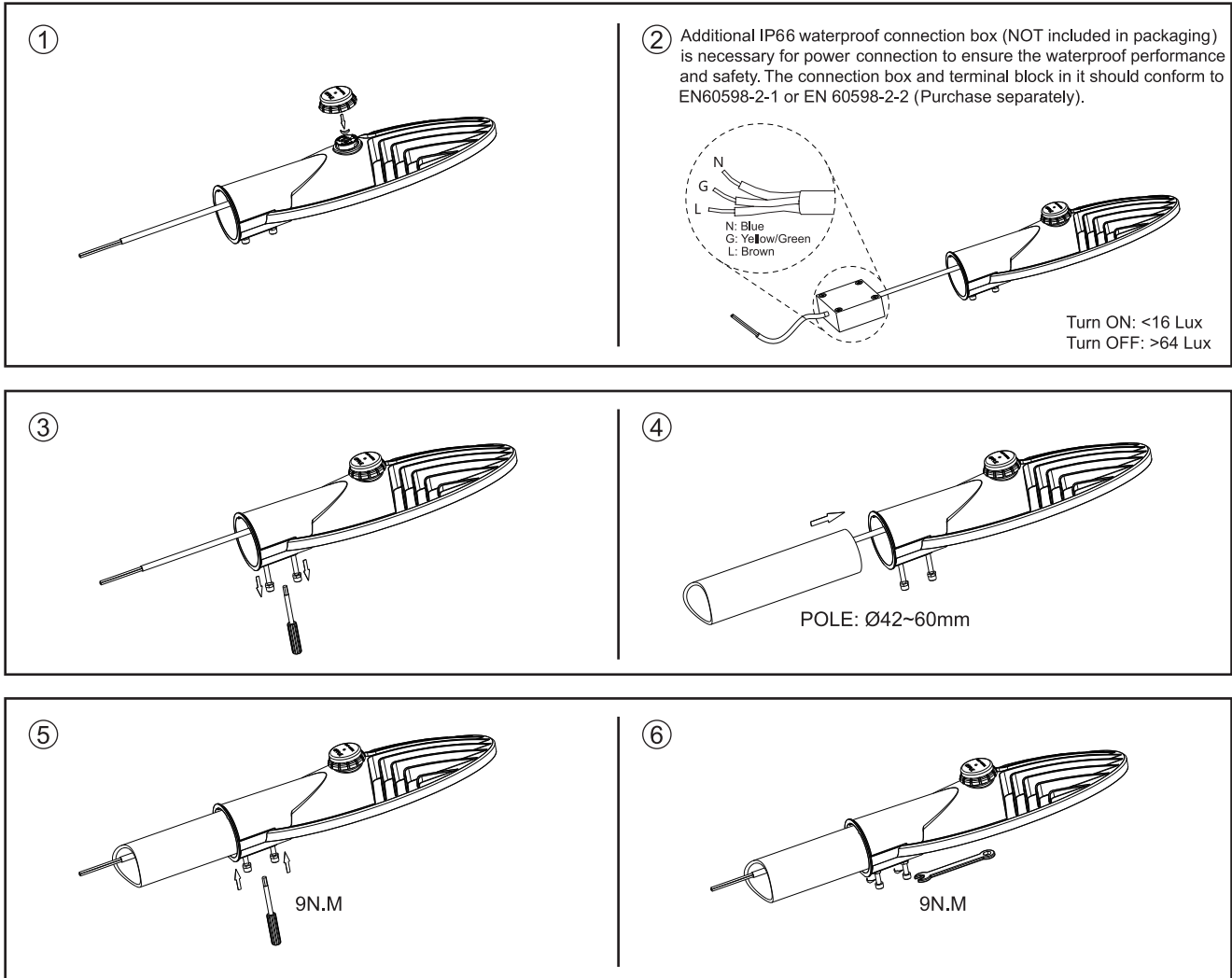

In case of damage to the wire, it has to be replaced only by the manufacturer, distributor or by an expert, to avoid risks.

Caution: Any operation on LED module is forbidden while power-on.

Zur Vermeidung von Risiken müssen defekte Leitungen ausschließlich vom Hersteller, Inverkehrbringer oder Fachmann ausgetauscht werden.

Achtung: In Betrieb ist keine Arbeit am LED-Modul erlaubt.

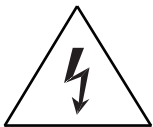

For non-user replaceable light sources.

The light source contained in this luminaire shall only be replaced by the manufacturer or his service agent or a similar qualified person.

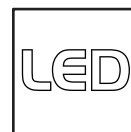
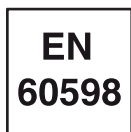

Suzhou Oppl Lighting Co.,Ltd.
215200
East Side, Fenyang Road,
Fenhu Economic Development Zone,
Wujiang City, Jiangsu Province,
P.R.China

Oppl Lighting BV
Meerenakkerweg 1.11
5652 AR Eindhoven
The Netherlands
service@oppl.com
www.oppl.com