

LED WALL MOUNTED

Item Code

CCT



543011000600	3000K/4000K	1.3Kg
543011000500	3000K/4000K	1.4Kg
543011000400	3000K/4000K	1.32Kg
543011000300	3000K/4000K	1.42Kg

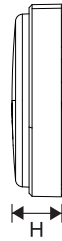
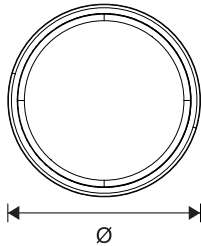
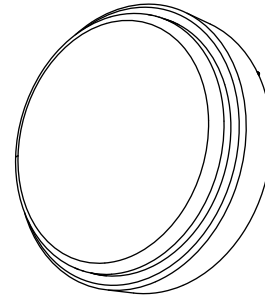

Model Name	Ø (mm)	H (mm)	Rated Voltage(V~)	Frequency (Hz)	Current (mA)	Rated Power(w)
LED-WM-P R300-15W	322	84	220-240	50/60	80	15
LED-WM-P R300-16.5W-MD	322	84	220-240	50/60	90	16.5
LED-WM-P R300-21W	322	84	220-240	50/60	120	21
LED-WM-P R300-22.5W-MD	322	84	220-240	50/60	130	22.5

Preparation

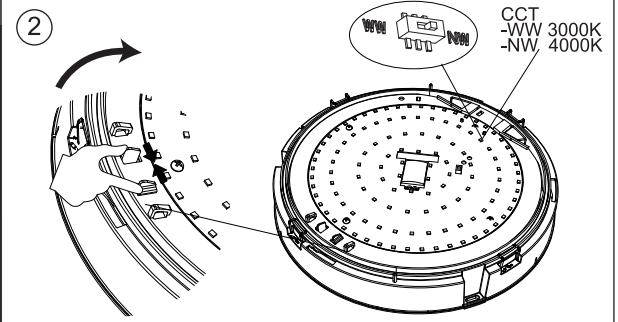
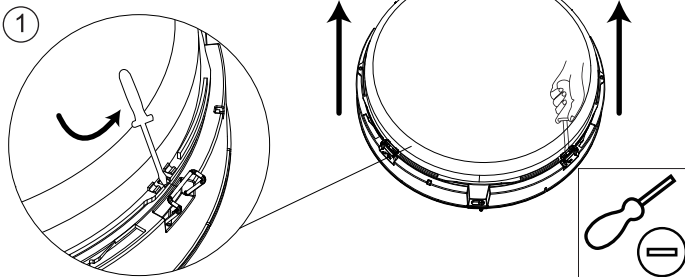

Wiring-Single luminaire

(For master-slave wiring see page#2)

○ ○ Ø6mm-Ø9mm
External Wire diameter
Min: 2×1.0mm²
Max: 2×2.5mm²

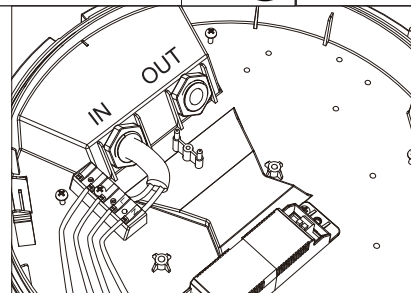
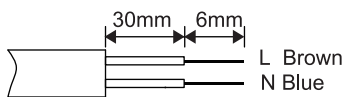

LED-WM-P R300-15W
LED-WM-P R300-21W

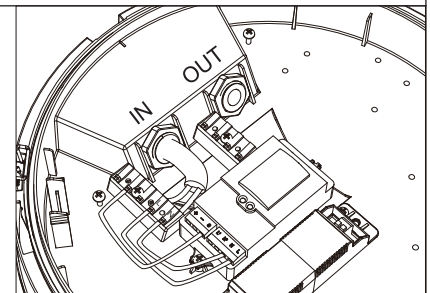

LED-WM-P R300-16.5W-MD
LED-WM-P R300-22.5W-MD

Mounting

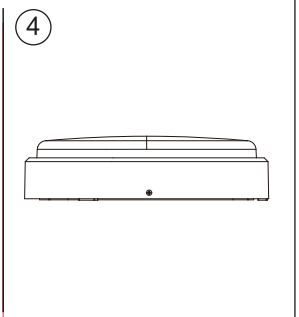
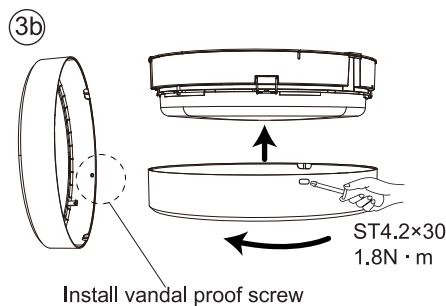
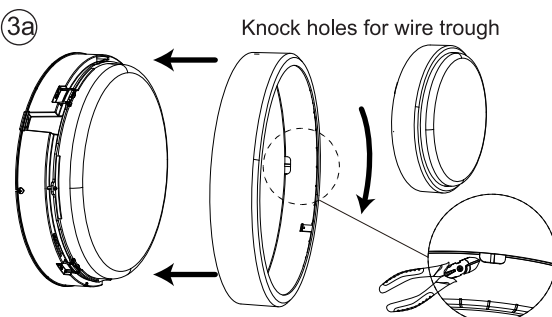
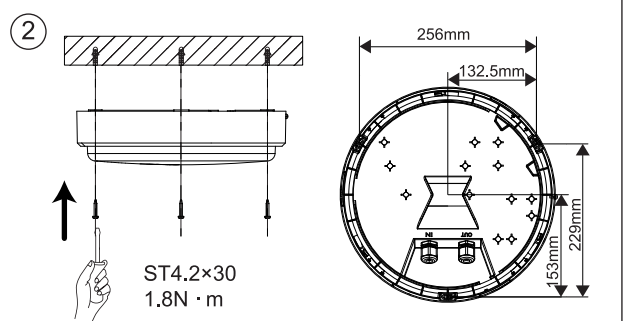
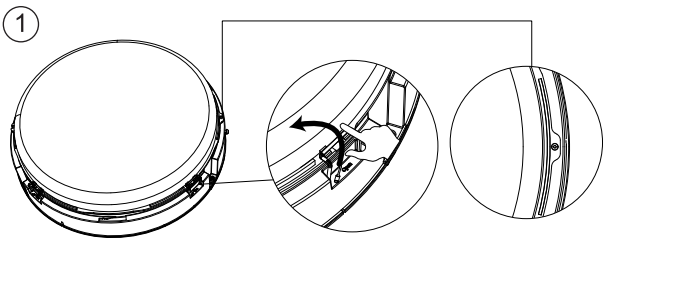

Master/Slave (with one sensor per line)

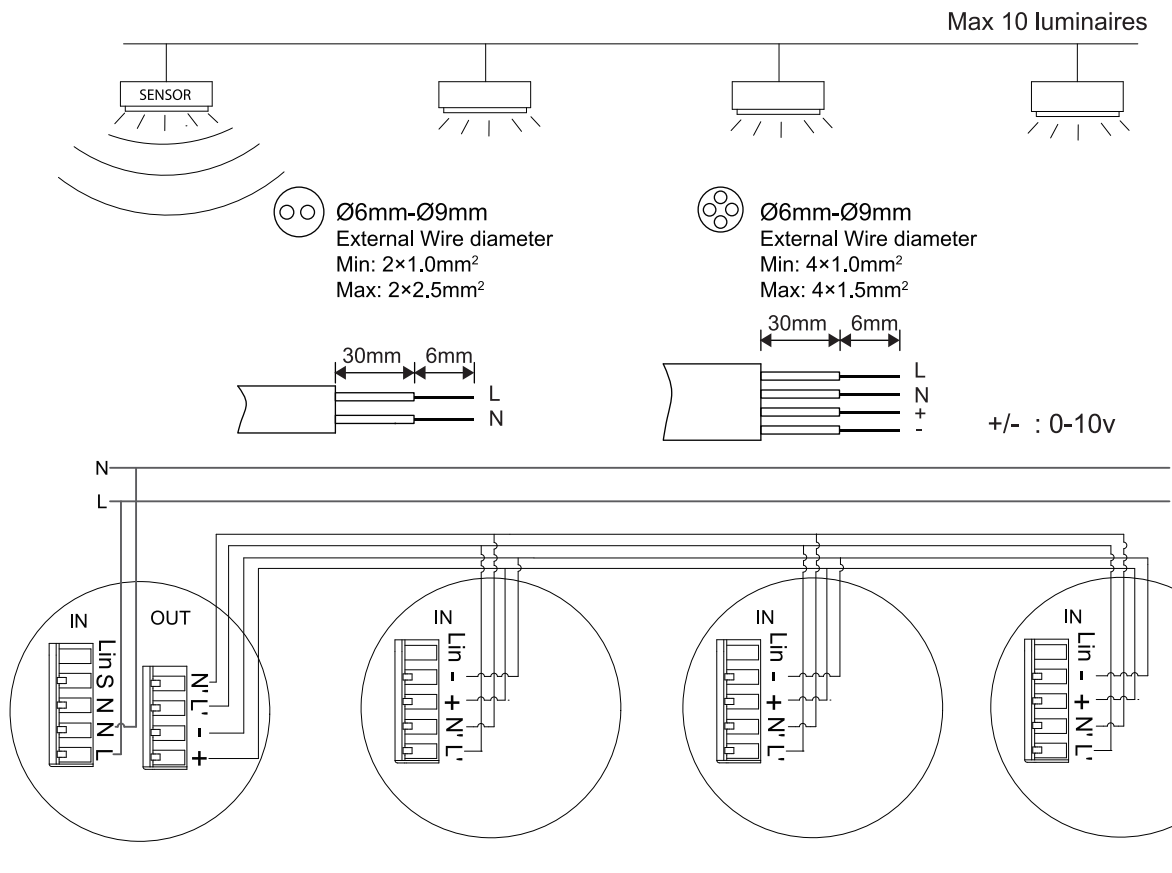

Master/Slave (with more than one sensor per line)

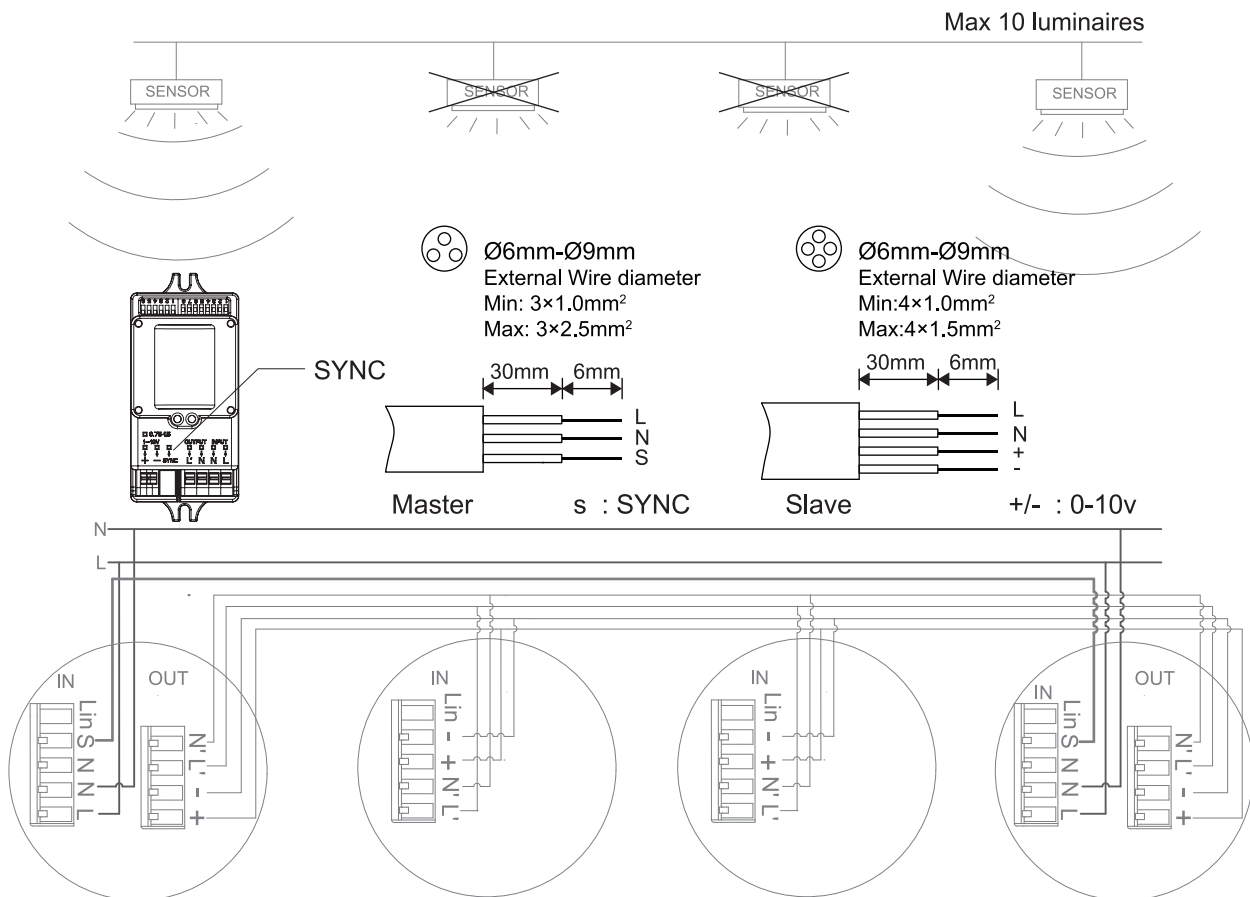

Dimming Function

Lamps in corridor are controlled by several sensors. Once any motion is detected by one of sensors, the motion signal will be transmitted to other sensors connected together. Then, all lamps switch on at the same time, instead of switching on the lamps in the area where motion is detected.

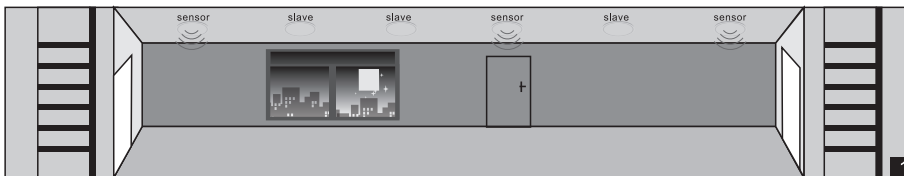

No motion detected, all lamps switch off.

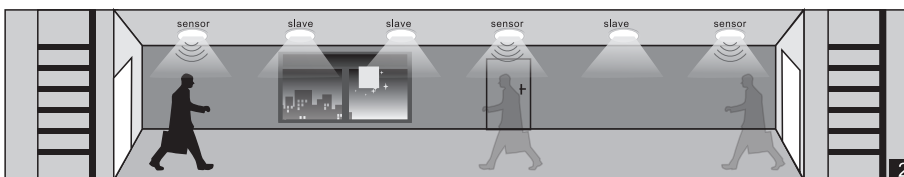

Any movement is detected from any direction, all lamps synchronously switch on.

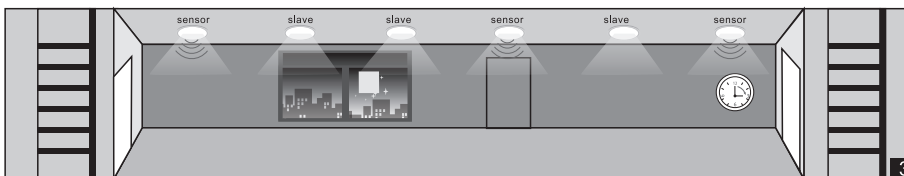

No motion is detected in detection area, all lamps synchronously dim to a low light level after hold time.

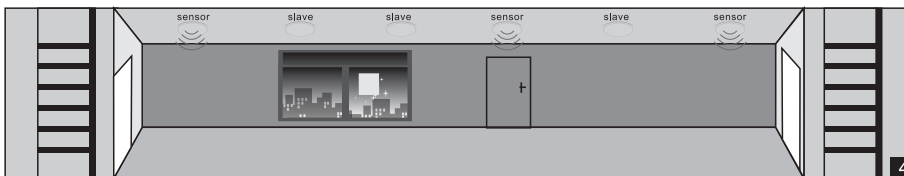

After stand-by period, the lamps switch off if no movement is detected in the detection zone.

Detection Pattern

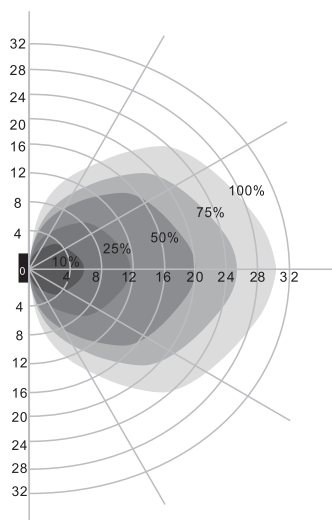

Wall mounting pattern (Unit: m)
Suggested installation height: 1-1.8m

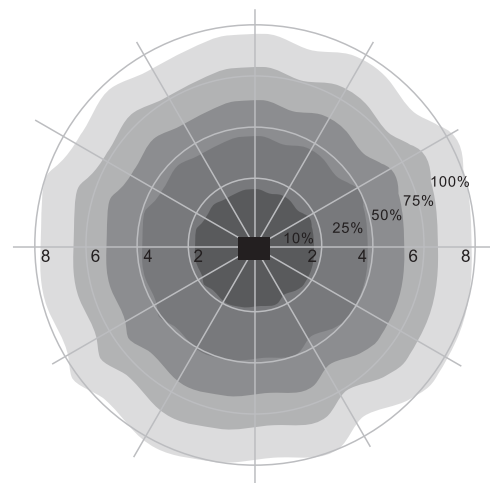

Ceiling mounting pattern (Unit: m)
Suggested installation height: 2.5-15m

Setting

By selecting the combination on the DIP switches, sensor data can be precisely set for each specific application.

ON ↑		1	2	
	I	ON	ON	100%
	II	ON	-	75%
	III	-	ON	50%
	IV	-	-	10%

ON ↑		3	4	5	
	I	ON	ON	ON	5s
	II	-	ON	ON	30s
	III	ON	-	ON	90s
	IV	-	-	ON	3min
	V	ON	ON	-	20min
	VI	-	-	-	+∞

ON ↑		6	7	8	
	I	ON	ON	ON	0s
	II	-	ON	ON	5s
	III	ON	-	ON	5min
	IV	-	-	ON	10min
	V	ON	ON	-	30min
	VI	-	ON	-	1h
	VII	-	-	-	+∞

ON ↑		1	2	3	4	
	I	-	-	ON	ON	2Lux
	II	-	-	-	ON	5Lux
	III	-	ON	ON	-	10Lux
	IV	-	-	ON	-	25Lux
	V	-	ON	-	-	50Lux
	VI	ON	-	-	-	100Lux
	VII	-	-	-	Disable	

ON ↑		5	6	
	I	ON	ON	50%
	II	-	ON	30%
	III	ON	-	20%
	IV	-	-	10%

Detection area

Detection area can be reduced by selecting the combination on the DIP switches to fit precisely each application .

Hold time

Refers to the time period the lamp remains at 100% illumination after no motion detected.

Stand-by period

Refers to the time period the lamp remains at a low light level before it completely switches off in the long absence of people.

When set to "+∞" mode, the low light is maintained until motion is detected.

Daylight sensor

The sensor can be set to only allow the lamp to illuminate below a defined ambient brightness threshold.

When set to Disable mode, the daylight sensor will switch on the lamp when motion is detected regardless of ambient light level.

50lux, 30lux: twilight operation, 10lux, 5lux: darkness operation only. Note that daylight sensor is active only when lamp totally switches off.

Stand-by dimming level

The low light level you would like to have after the hold time in the long absence of people.

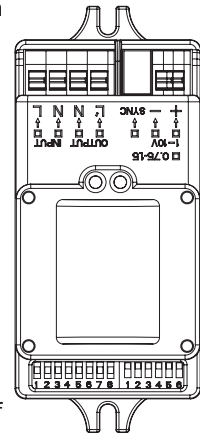

Components



Components included in the packaging inside the components box.



Caution: Any operation on LED module is forbidden while power-on.
Zur Vermeidung von Risiken müssen defekte Leitungen ausschließlich vom Hersteller, Inverkehrbringer oder Fachmann ausgetauscht werden.
Achtung: In Betrieb ist keine Arbeit am LED-Modul erlaubt.



For non-user replaceable light sources:
The light source contained in this luminaire shall only be replaced by the manufacturer or his service agent or a similar qualified person.

Das Leuchtmittel dieser Leuchte ist nicht austauschbar. Wenn das Leuchtmittel das Ende seiner Lebensdauer erreicht hat, muss die gesamte Leuchte ersetzt werden.



For use in environments where normal non-conductive/conductive dust accumulation may be expected, not for use in environments with expected high/unusual dust accumulation.

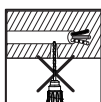
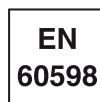
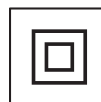
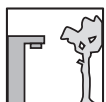

Data subject to change
Les données sont sujettes à modifications
Änderungen vorbehalten

Opplé Lighting Electronic (Zhongshan) Co., Ltd.
528422
Building A, No.275 Dongan Bei Road,
Haizhou District, Guzhen Town,
Zhongshan City, Guangdong, China.

OPPLE Lighting B.V.
Materiaalweg 6-6A
5681 RJ Best
The Netherlands
service@opple.com
www.opple.com