

## Waterproof Performer G4

- Feuchtraumwannenleuchte im speziellen "Lebenslang wasserdicht" Design
- Schnelle Montage durch schraubenlose Endkappe (Drehverschluss)
- Einschließlich vandalensicherer Decken- und Aufhängeclipsen aus Edelstahl



## Artikeldaten

Artikelnummer	Artikelbeschreibung	Ersatz für (W)	Watt (W)	Lumen	Lichtausbeute (lm/W)	CCT (K)	Interne Verdrahtung (mm <sup>2</sup> )	Max. Durchmesser des Eingangskabels (mm)	Gewicht (kg/st)
Smart									
711000007100	LEDWaterproof-P4 L1489-31W-BLE2-840	TL 1x58W	31	4650	150	4000	3x2,5	7-11	1,21

## Produkt- und Verpackungsinformationen

Artikel			Verpackung			
Artikelnummer	Artikelbeschreibung	EU HS Code	Abmessungen (mm) (LxBxH)	Bruttogewicht (kg)	EAN	Stück/Karton
711000007100	LEDWaterproof-P4 L1489-31W-BLE2-840	94051190	1497x70x80	1,50	6931783015124	1
560006000900	LEDsmart-Sensor IP65-Base-Module	94059200	140x140x150	0,56	6941497726063	1
560006001000	LEDsmart-Sensor IP65-Module	94059200	145x120x150	0,55	6941497726056	1
560098000600	LEDsmart-Sensor Surface-Module-WH	94059200	330x220x255	0,15	6941497703972	1
821006001800	LEDsmart-BLE2-Rc-MW-Sensor	85365005	100x100x130	0,19	6941497778277	1
821006002000	LEDsmart-BLE2-Rc-PIR-Sensor	85365005	100x100x70	0,19	6941497778260	1
821009000200	LEDsmart-BLE2-Switch	85365005	89x21x101	0,10	6941497778253	1
821011002600	LEDsmart-BLE2-DALI-Connect-Box	85176200	100x60x105	0,30	6941497778291	1
821017003400	LEDsmart-BLE2-Multi-Switch-Module	94059200	46x46x30	0,07	6931783007600	1
821017003800	LEDsmart-BLE2-Relay-1000W	85364900	110x57x37	0,10	6941497778284	1

Technische Daten	
Lebensdauer (L70)	100.000 h
Lebensdauer (L80)	80.000 h
Ein-/aus-Zyklen	100.000
Farbbeständigkeit (SDCM)	4
Steuerbar	BLE2
Abstrahlwinkel	120°
Farbe	Grau RAL 7035
CRI	> 80
Schutzart (IP)	IP66
Schlagfestigkeit	IK08
Schutzklasse	II
Risikogruppe (EN 62471)	RG0
Mit Betriebsgerät	Ja
Glüdrahtprüfung	850°C
Leistungsfaktor	≥ 0,9
Durchmesser Aderquerschnitt	1mm <sup>2</sup> - 2.5mm <sup>2</sup>

Stromversorgung	
Frequenz	50/60 Hz
Nennspannung	220-240 V
DC input voltage	Siehe Kataloganhang, Anschlußwerte und Gleichstromlichkeit (DC-fähig)

Material	
Gehäusematerial	Polycarbonat
UV-beständig	Ja
Optisches Material	Polycarbonat
Montage clips	rostfreier Stahl

Anwendungsmöglichkeiten	
Betriebstemperatur	-30-+45°C
Anwendungstemperatur	+25°C
Lagertemperatur	-30-+50°C

**5** JAHRE  
GARANTIE



## Produktmaße (mm)

LEDWaterproof-P4 L1489

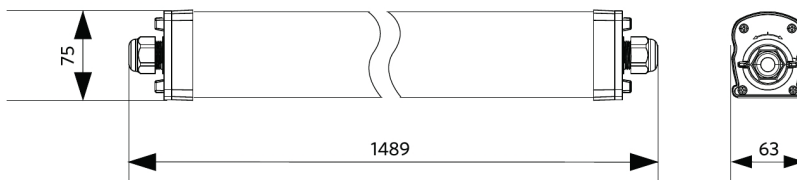

## Installations-Varianten

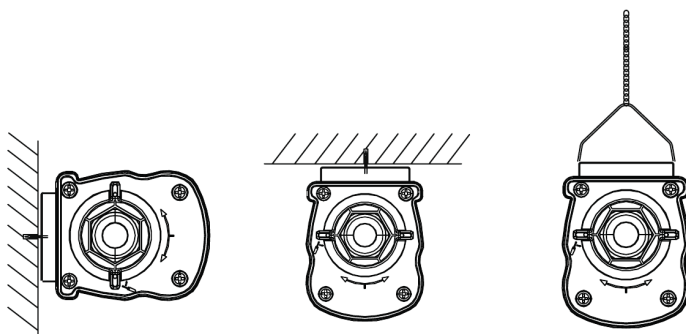

## Lichttechnische Daten

