



Downlight Performer HG

- Advanced high quality LED downlight
- Unique optical lens concept with high gloss (HG) reflector and low glare
- Low luminaire height (max 73mm)
- Direct replacement for compact fluorescent downlights
- IP44 on light emitting side
- Provided with protective foil in order to protect the optics against dust and dirt during the installation



Specifications

Item Code	Item Description	Equivalent to (W)	Power (W)	Lumen	Efficacy (lm/W)	UGR	CCT (K)	Colour rendering index (CRI)	Weight (kg/pc)
On-Off									
140057154	LEDDownlightRc-P-HG R150-11.5W-3000	CFL 1x18W	11.5	1240	108	≤19	3000	> 80	0.45

Accessories



140060646
LEDDownlightRc-P-HZ-Adapter-150-175



140061242
LEDDownlightRc-P-R150-Surface-Module-WH



549098001300
LEDDownlightRc-P EM-kit 1h

549098001400
LEDDownlightRc-P EM-kit 3h



542098030700
Junction-Box-WH

Packaging Information

Item			Box			
Item Code	Item Description	EU HS Code	Dimensions (mm) (LxWxH)	Gross Weight (kg)	EAN	pc/box
140057154	LEDDownlightRc-P-HG R150-11.5W-3000	94051190	200x200x103	0.73	6956712692580	1
140060646	LEDDownlightRc-P-HZ-Adapter-150-175	94059900	200x200x0.8	0.18	6956321894122	1
140061242	LEDDownlightRc-P-R150-Surface-Module-WH	94059900	222x222x280	2.35	6956321840655	1
542098030700	Junction-Box-WH	85369010	43x103.4x26	0.06	6941408868684	1
549098001300	LEDDownlightRc-P EM-kit 1h	85044083	490x390x150	0.98	6941497709592	1
549098001400	LEDDownlightRc-P EM-kit 3h	85044083	490x390x150	1.08	6941497709585	1

Technical Specifications	
Lifetime (L70)	70,000 h
Lifetime (L80)	50,000 h
On-/Off-cycles	100,000
Colour consistency (SDCM)	3
Dimmability	On-Off
Beam angle	70°
Finishing	White RAL9003
IP front side	IP44
IP recessed part	IP20
Impact strength	IK02
Protection class	II
Risk group (EN 62471)	RG0 / RG1 (23W & 33W)
With control gear	Yes
Glow wire test	650°C
Power factor	≥ 0.9

Electrical Supply	
Frequency	50/60 Hz
Nominal voltage	220-240 V
DC input voltage	See catalogue appendix Connection Specifications
230V Cable length	0.3 m

Mechanical Properties	
Housing material	Die-casted Aluminum
Optical material	Polycarbonate

Ambient Conditions	
Operating temperature	-10-+40°C
Application temperature	+25°C
Storage environment	-25-+50°C

5 YEARS WARRANTY



ENERGY

OPPLE Lighting
140057154

12
kWh/1000h

2019/2015

Dimensional Drawing (mm)

LEDDownlightRc-P-HG R150

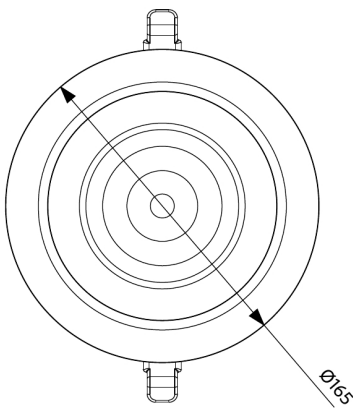

LEDDownlight Driver

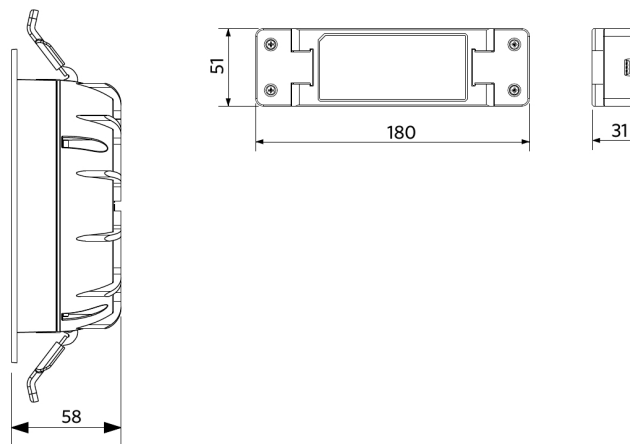

LEDDownlight Driver Tunable White

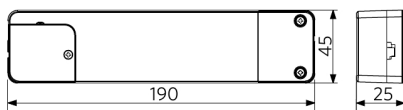

LEDDownlightRc-P-HG R150
LEDDownlightRc-P-R150-Surface-Module



Photometric Data

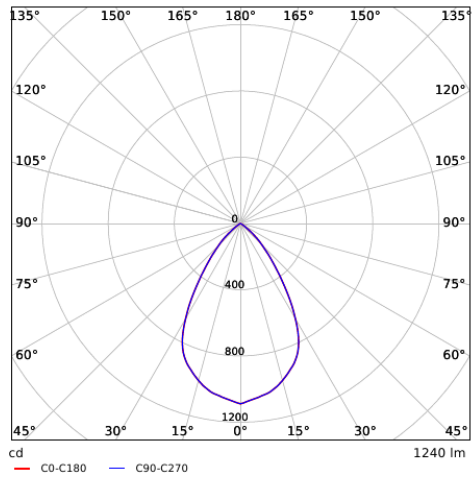

Installation Opening Drawing (mm)

LEDDownlightRc-P-HG R150
Ø150

