



Waterproof Classic G2

- New more sleek classic waterproof solution with clip design
- Improved efficacy of 150 lm/W
- Optimized diffuser design for more uniform illumination patterns
- Wiring from the back or side possible
- Supplied with vandal-proof stainless steel ceiling and suspension clips
- 3x25mm² wire through kit available as accessory



Specifications

Item Code	Item Description	Equivalent to (W)	Power (W)	Lumen	Efficacy (lm/W)	CCT (K)	Weight (kg/pc)
Emergency version 3 hours, On-Off							
531000015800	LEDWP-CLA-P2 L1500-24/44W-840-EM3	TL 1/2x58W	24/44	3600/6600	150	4000	1.86

Accessories



531098002500
LEDWP-CLA-P2 Wirethrough-Kit



531098002700
LEDWP-CLA-P2 Sensor-Kit

Packaging Information

Item			Box			
Item Code	Item Description	EU HS Code	Dimensions (mm) (LxWxH)	Gross Weight (kg)	EAN	pc/box
531000015800	LEDWP-CLA-P2 L1500-24/44W-840-EM3	94051190	1513x81x75	2.29	6931783031117	1
531098002500	LEDWP-CLA-P2 Wirethrough-Kit	76169990	760x55x1	0.14	6931783035191	1
531098002700	LEDWP-CLA-P2 Sensor-Kit	85365005	105x18x16	0.02	6931783035214	1

Technical Specifications

Lifetime (L70)	70,000 h
Lifetime (L80)	50,000 h
On-/Off-cycles	100,000
Colour consistency (SDCM)	4
Dimmability	On-Off
Sensor type	No sensor
Sensor technology	No sensor
Beam angle	120°
Finishing	Grey RAL 7035
Colour rendering index (CRI)	> 80
Degree of protection (IP)	IP66
Impact strength	IK08
Protection class	I
Risk group (EN 62471)	RG1
With control gear	Yes
Glow wire test	850°C
Power factor	≥ 0.9
Input wire diameter	1mm ² - 2.5mm ²
Internal wiring (mm ²)	3x2.5
Max. input cable diameter (mm)	5-11 mm

Electrical Supply

Frequency	50/60 Hz
Nominal voltage	220-240 V
DC input voltage	See catalogue appendix Connection Specifications

Mechanical Properties

Material housing	Polycarbonate
UV resistant	Yes
Optical material	Polycarbonate
Mounting clips	Stainless steel

Ambient Conditions

Operating temperature	-20-+45°C
Application temperature	+25°C
Storage environment	-30-+60°C



Dimensional Drawing (mm)

LEDWP-CLA-P2 L1500

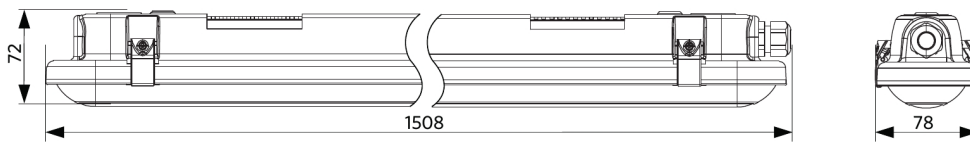

Installation Possibilities

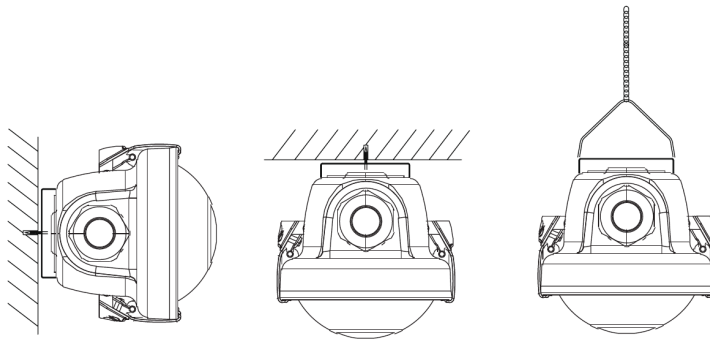

Photometric Data

