



Waterproof Classic G2

- Sleek classic waterproof solution with clip design
- Improved efficacy of 150 lm/W
- Optimized diffuser design for more uniform illumination patterns
- Wiring from the back or side possible
- Supplied with vandal-proof stainless steel ceiling and suspension clips
- Wire through kits available as accessory



Specifications

Item Code	Item Description	Equivalent to (W)	Power (W)	Lumen (lm)	Efficacy (lm/W)	CCT (K)	Net Weight (kg/pc)
Emergency kit 3 hour/Motion Detection/Daylight Detection							
531000017600	LEDWP-CLA-P2 L1500-24/44W-840-MD-EM3	TL 1/2x58W	24 - 44	3600 - 6600	150	4000	1.88

Accessories



531098002500
LEDWP-CLA-P2
Wirethrough-Kit

Packaging information

Item			Box			
Item Code	Item Description	EU HS Code	Dimensions (mm) (LxWxH)	Gross Weight (kg/pc)	EAN	pc/box
531000017600	LEDWP-CLA-P2 L1500-24/44W-840-MD-EM3	94051190	1513x81x75	2.31	6931783031148	1
531098002500	LEDWP-CLA-P2 Wirethrough-Kit	76169990	760x55x10	0.14	6931783035191	1

Technical Specifications

Lifetime (L70)	100,000 h
Lifetime (L80)	70,000 h
On-/Off-cycles	100,000
Colour consistency (SDCM)	4
Dimmability	Sensor controlled (MD)
Sensor type	Motion + Daylight detection (MD)
Sensor technology	Microwave (MW)
Beam angle	120 °
Finishing	Grey RAL 7035
RAL-Number	7035
Colour rendering index (CRI)	> 80
Efficacy (lm/W)	150 lm/W
Ingress Protection (IP)	IP66
Impact strength (IK)	IK08
Protection class	I
Risk group (EN 62471)	RG1
With control gear	True
Glow wire test	850 °C
Driver failure rate (at 5,000 hrs)	≤ 0.5 %
Power factor	≥ 0.9
Input wire Ø (mm)	1mm ² - 2.5mm ²
Internal wiring (mm ²)	3x2.5
Input cable Ø (mm)	5 - 11 mm ²

Electrical Supply

Frequency	50 - 60 Hz
Nominal voltage	220 - 240 V
DC input voltage	See catalogue appendix Connection Specifications

Mechanical Properties

Housing material	Polycarbonate
UV resistant	Yes
Optical material	Polycarbonate
Mounting clips	Stainless steel

Ambient Conditions

Operating temperature (EM)	0 - 45 °C
Application temperature	25 °C
Storage environment (EM)	0 - 60 °C



Dimensional Drawing (mm)

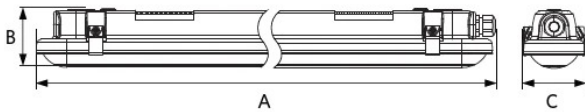

Type	A	B	C
L600	607	72	78
L1200	1208	72	78
L1500	1508	72	78

Installation Possibilities

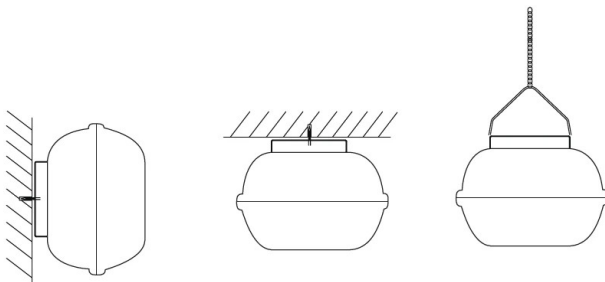

Motion Sensors

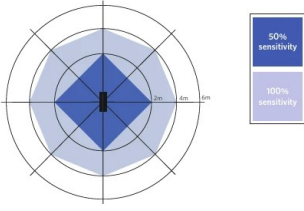

Installation - Ceiling mounted
Suggested installation height 3-4m

Photometric Data

