



## Downlight Performer MW

- Advanced high quality LED downlight
- Unique optical lens concept with matte white (MW) reflector and low glare
- Low luminaire height (max 73mm)
- Direct replacement for compact fluorescent downlights
- IP44 on light emitting side
- Provided with protective foil in order to protect the optics against dust and dirt during the installation



## Specifications

Item Code	Item Description	Equivalent to (W)	Power (W)	Lumen	Efficacy (lm/W)	UGR	CCT (K)	Colour rendering index (CRI)	Weight (kg/pc)
<b>On-Off</b>									
540001086400	LEDDownlightRc-P-MW R200-23W-940	CFL 2x26W	23	2530	110	≤22	4000	> 90	0.76

## Accessories



140060647  
LEDDownlightRc-P-SI-E-Adapter-200-225



140061243  
LEDDownlightRc-P-R200-Surface-Module-WH



549098001300  
LEDDownlightRc-P EM-kit 1h



542098030700  
Junction-Box-WH

140060648  
LEDDownlightRc-P-SI-E-Adapter-200-250

549098001400  
LEDDownlightRc-P EM-kit 3h

## Packaging Information

Item			Box			
Item Code	Item Description	EU HS Code	Dimensions (mm) (LxWxH)	Gross Weight (kg)	EAN	pc/box
540001086400	LEDDownlightRc-P-MW R200-23W-940	94051190	260x260x118	1.18	6941408832005	1
140060647	LEDDownlightRc-P-SI-E-Adapter-200-225	94059900	250x250x0.8	0.23	6956321894139	1
140060648	LEDDownlightRc-P-SI-E-Adapter-200-250	94059900	275x275x0.8	0.20	6956321894146	1
140061243	LEDDownlightRc-P-R200-Surface-Module-WH	94059900	277x277x240	2.66	6956321841416	1
542098030700	Junction-Box-WH	85369010	43x103.4x26	0.06	6941408868684	1
549098001300	LEDDownlightRc-P EM-kit 1h	85044083	490x390x150	0.98	6941497709592	1
549098001400	LEDDownlightRc-P EM-kit 3h	85044083	490x390x150	1.08	6941497709585	1

Technical Specifications	
Lifetime (L70)	70,000 h
Lifetime (L80)	50,000 h
On-/Off-cycles	100,000
Colour consistency (SDCM)	3
Dimmability	On-Off
Beam angle	70°
Finishing	White RAL9003
IP front side	IP44
IP recessed part	IP20
Impact strength	IK02
Protection class	II
Risk group (EN 62471)	RG0 / RG1 (23W, 33W & 44W)
With control gear	Yes
Glow wire test	650°C
Power factor	≥ 0.9

Electrical Supply	
Frequency	50/60 Hz
Nominal voltage	220-240 V
DC input voltage	See catalogue appendix Connection Specifications
230V Cable length	0.3 m

Mechanical Properties	
Housing material	Die-casted Aluminum
Optical material	Polycarbonate

Ambient Conditions	
Operating temperature	-10-+40°C
Application temperature	+25°C
Storage environment	-25-+50°C

**5 YEARS WARRANTY**



**ENERGY**

OPPLE Lighting  
540001086400

**23**  
kWh/1000h

2019/2015

## Dimensional Drawing (mm)

LEDDownlight Driver

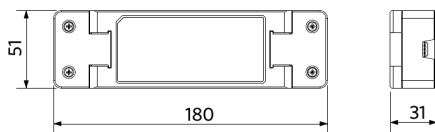

LEDDownlightRc-P-MW R200

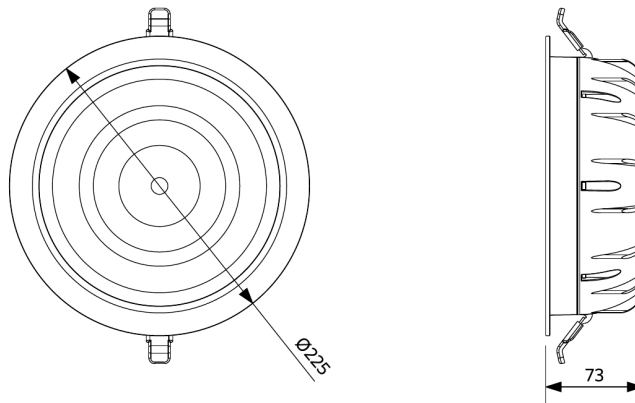

LEDDownlight Driver Tunable White



LEDDownlightRc-P-MW R200  
LEDDownlightRc-P-R200-Surface-Module

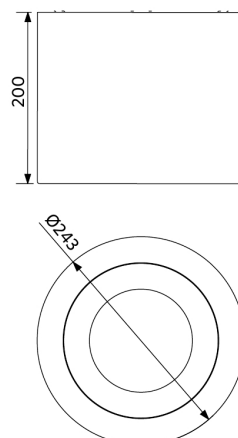

## Photometric Data

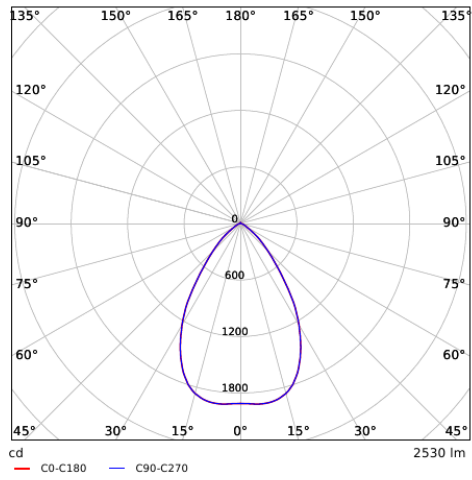

## Installation Opening Drawing (mm)

LEDDownlightRc-P-MW R200  
Ø200

