











- Premium side-lit LED Slim Panel, suitable for offices (UGR19)
- Ultra-slim panel (9mm), ideal for suspended use
- Recessed, suspended and surface mounting possible



Specifications

| Item Code | Item Description | Equivalent to (W) | Power (W) | Lumen | Efficacy (lm/W) | CCT (K) | Colour rendering index (CRI) | Weight (kg/pc) |
|--------------|--------------------------------------|-------------------|-----------|-------|-----------------|---------|------------------------------|----------------|
| DALI2 | | | | | | | | |
| 542004068900 | LEDPanelRc-S5 Sq595-30W-DALI-830-U19 | TL 4x18W | 30 | 3750 | 125 | 3000 | > 80 | 2.49 |

Accessories

| | | | | | | |
|---|---|---|---|---|---|--|
| Surface Mounting Frame | | Recessed Mounting Frame | | | | |
|  |  |  |  |  |  | |
| 140055484 LEDPanelRc-SI Sq600-Surface-Module-WH-CT | 542098017600 LEDPanelRc2 Sq600-Surface-Kit-WH | 542098009600 LEDPanelRc Sq600-Frame-WH | 140057770 LEDPanelRc-SI-Mounting-Springs-595 | 542098006900 LEDPanel-S4-Suspension-Kit | 542098000800 LEDPanelRC-SI U19 EM-kit 1h | |
| | | | | | 542098000900 LEDPanelRC-SI U19 EM-kit 3h | |
|  |  | | | | | |
| 140060852 LEDFixture-Ceiling-Cable-Kit-0.5m | 542098030700 Junction-Box-WH | | | | | |

Packaging Information

| Item | | | Box | | | |
|--------------|--|------------|----------------------------|-------------------|---------------|--------|
| Item Code | Item Description | EU HS Code | Dimensions (mm) (LxWxH) | Gross Weight (kg) | EAN | pc/box |
| 542004068900 | LEDPanelRc-S5 Sq595-30W-DALI-830-U19 | 94051190 | 661x695x46 | 3.57 | 6941497735836 | 1 |
| 140055484 | LEDPanelRc-SI Sq600-Surface-Module-WH-CT | 94059900 | 690x690x118 | 4.26 | 6956321879808 | 1 |
| 140057770 | LEDPanelRc-SI-Mounting-Springs-595 | 73209090 | 80x80x53 | 0.50 | 6956321888121 | 1 |
| 140060852 | LEDFixture-Ceiling-Cable-Kit-0.5m | 73121020 | 100x100x5 | 0.40 | 6956321895266 | 1 |
| 542098000800 | LEDPanelRC-SI U19 EM-kit 1h | 85044083 | 490x390x150 | 0.98 | 6941497702340 | 1 |
| 542098000900 | LEDPanelRC-SI U19 EM-kit 3h | 85044083 | 490x390x150 | 1.08 | 6941497702333 | 1 |
| 542098001000 | LEDTrunking DALI Power Supply | 85044083 | 198x54x39 | 0.24 | 6945730496614 | 1 |
| 542098006900 | LEDPanel-S4-Suspension-Kit | 73121020 | 130x130x30 | 0.22 | 6941497701428 | 1 |
| 542098009600 | LEDPanelRc Sq600-Frame-WH | 94059900 | 688x88x694 | 1.79 | 6941497704061 | 1 |
| 542098017600 | LEDPanelRc2 Sq600-Surface-Kit-WH | 94059900 | 685x77x68 | 1.53 | 6941497720696 | 1 |
| 542098030700 | Junction-Box-WH | 85369010 | 43x103.4x26 | 0.06 | 6941408868684 | 1 |

Technical Specifications

| | |
|---------------------------|---------------|
| Lifetime (L70) | 100,000 h |
| Lifetime (L80) | 70,000 h |
| Lifetime (L90) | 50,000 h |
| On-/Off-cycles | 100,000 |
| Colour consistency (SDCM) | 3 |
| Dimmability | DALI |
| Beam angle | 85° |
| Finishing | White RAL9003 |
| UGR | ≤ 19 |
| IP front side | IP54 |
| IP recessed part | IP20 |
| Impact strength | IK04 |
| Protection class | II |
| Risk group (EN 62471) | RG0 |
| With control gear | Yes |
| Glow wire test | 650°C |
| Power factor | ≥ 0.9 |

Electrical Supply

| | |
|-------------------|------------------------|
| Frequency | 50/60 Hz |
| Nominal voltage | 220-240 V |
| DC input voltage | See catalogue appendix |
| Connection | Specifications |
| 230V Cable length | 1 m |

Mechanical Properties

| | |
|------------------|------------------|
| Housing material | Aluminum |
| Optical material | PMMA |
| Cover material | Polystyrene (PS) |

Ambient Conditions

| | |
|-------------------------|-----------|
| Operating temperature | -20-+40°C |
| Application temperature | +25°C |
| Storage environment | -25-+50°C |

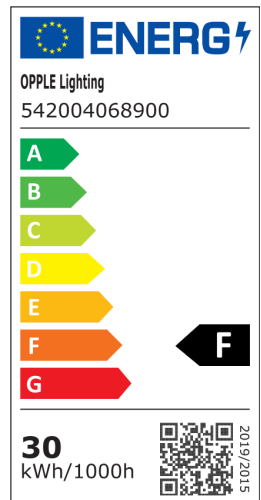

Dimensional Drawing (mm)

LEDPanelRc-S5 Sq595

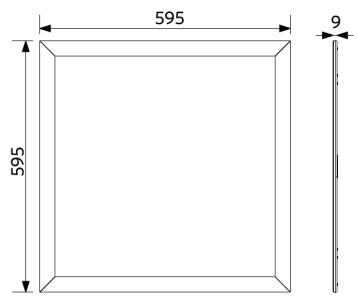

LEDPanelRc-S5 Driver On/Off

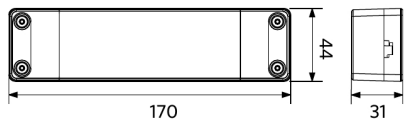

LEDPanelRc-S5 Driver Dim

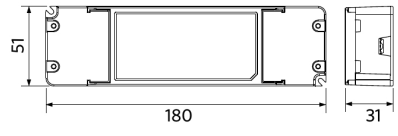

LEDPanelRc-S5 Driver Tunable White

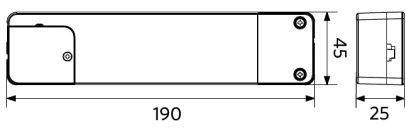

Photometric Data

