



- Premium side-lit LED Slim Panel, suitable for offices (UGR19)
- Ultra-slim panel (9mm), ideal for suspended use
- Recessed, suspended and surface mounting possible



Specifications

Item Code	Item Description	Equivalent to (W)	Power (W)	Lumen	Efficacy (lm/W)	CCT (K)	Colour rendering index (CRI)	Weight (kg/pc)
Smart								
542004094800	LEDPanelRc-S5 Sq620-34W-BLE2-940-U19	TL 4x18W	34	3910	115	4000	> 90	2.62

Accessories



542098006900
LEDPanel-S4-Suspension-Kit



542098000800
LEDPanelRC-SI U19 EM-kit 1h

542098000900
LEDPanelRC-SI U19 EM-kit 3h



140060852
LEDFixture-Ceiling-Cable-Kit-0.5m



542098030700
Junction-Box-WH

Packaging Information

Item			Box			
Item Code	Item Description	EU HS Code	Dimensions (mm) (LxWxH)	Gross Weight (kg)	EAN	pc/box
542004094800	LEDPanelRc-S5 Sq620-34W-BLE2-940-U19	94051190	688x722x46	3.74	6941497785398	1
140055485	LEDPanelRc-SI Sq625-Surface-Module-WH-CT	94059900	715x715x118	4.77	6956321879815	1
140057771	LEDPanelRc-SI-Mounting-Springs-622	73209090	80x80x53	0.16	6956321888138	1
140060852	LEDFixture-Ceiling-Cable-Kit-0.5m	73121020	100x100x5	0.40	6956321895266	1
542098000800	LEDPanelRC-SI U19 EM-kit 1h	85044083	490x390x150	0.98	6941497702340	1
542098000900	LEDPanelRC-SI U19 EM-kit 3h	85044083	490x390x150	1.08	6941497702333	1
542098006900	LEDPanel-S4-Suspension-Kit	73121020	130x130x30	0.22	6941497701428	1
542098009700	LEDPanelRc Sq625-Frame-WH	94059900	715x88x721	1.84	6941497704054	1
542098017500	LEDPanelRc2 Sq625-Surface-Kit-WH	94059900	812x77x68	1.59	6941497720689	1
542098030700	Junction-Box-WH	85369010	43x103.4x26	0.06	6941408868684	1
560098000600	LEDsmart-Sensor Surface-Module-WH	94059200	330x220x255	0.15	6941497703972	1
821006001800	LEDsmart-BLE2-Rc-MW-Sensor	85365005	100x100x130	0.19	694149778277	1
821006002000	LEDsmart-BLE2-Rc-PIR-Sensor	85365005	100x100x70	0.19	694149778260	1
821009000200	LEDsmart-BLE2-Switch	85365005	89x21x101	0.10	694149778253	1
821011002600	LEDsmart-BLE2-DALI-Connect-Box	85176200	100x60x105	0.30	694149778291	1
821017003400	LEDsmart-BLE2-Multi-Switch-Module	94059200	46x46x30	0.07	6931783007600	1
821017003800	LEDsmart-BLE2-Relay-1000W	85364900	110x57x37	0.10	694149778284	1

Technical Specifications

Lifetime (L70)	100,000 h
Lifetime (L80)	70,000 h
Lifetime (L90)	50,000 h
On-/Off-cycles	100,000
Colour consistency (SDCM)	3
Dimmability	BLE2
Beam angle	85°
Finishing	White RAL9003
UGR	≤ 19
IP front side	IP54
IP recessed part	IP20
Impact strength	IK04
Protection class	II
Risk group (EN 62471)	RG0
With control gear	Yes
Glow wire test	650°C
Power factor	≥ 0.9

Electrical Supply

Frequency	50/60 Hz
Nominal voltage	220-240 V
DC input voltage	See catalogue appendix
	Connection Specifications
230V Cable length	1 m

Mechanical Properties

Housing material	Aluminum
Optical material	PMMA
Cover material	Polystyrene (PS)

Ambient Conditions

Operating temperature	-20-+40°C
Application temperature	+25°C
Storage environment	-25-+50°C



ENERGY

OPPLE Lighting
542004094800

A

B

C

D

E

F

G

F

34
kWh/1000h

2019/2015

Dimensional Drawing (mm)

LEDPanelRc-S5 Sq620

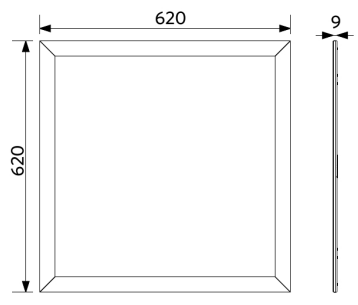

LEDPanelRc-S5 Driver On/Off

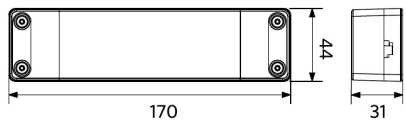

LEDPanelRc-S5 Driver Dim

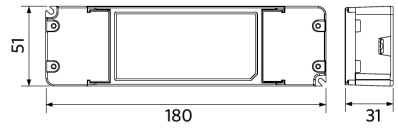

LEDPanelRc-S5 Driver Tunable White

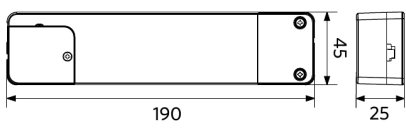

Photometric Data

