



Waterproof Performer G3

- Powerful range of waterproof luminaires in specific "sealed for life" design
- Quick installation thanks to its screwless endcap
- Supplied with vandal-proof stainless steel ceiling and suspension clips



Specifications

Item Code	Item Description	Equivalent to (W)	Power (W)	Lumen	Efficacy (lm/W)	CCT (K)	Internal wiring (mm ²)	Max. input cable diameter (mm)	Weight (kg/pc)
543022023700	LEDWaterproof-P3 L1610-31W-4000-PLUS-EM3	TL 1x58W	31	4340	140	4000	5x2.5	8-14	1.77

Packaging Information

Item			Box			
Item Code	Item Description	EU HS Code	Dimensions (mm) (LxWxH)	Gross Weight (kg)	EAN	pc/box
543022023700	LEDWaterproof-P3 L1610-31W-4000-PLUS-EM3	94051190	1652x84x81	2.01	6941408855974	1
506005002100	LEDWaterproof-P3-Mounting Kit	73269098	290x290x240	0.07	6941408831244	1

Technical Specifications

Lifetime (L70)	70,000 h
Lifetime (L80)	60,000 h
Lifetime (L90)	50,000 h
On-/Off-cycles	100,000
Colour consistency (SDCM)	4
Dimmability	On-Off
Beam angle	110°
Finishing	Grey RAL 7035
Colour rendering index (CRI)	≥ 80
Degree of protection (IP)	IP66
Impact strength	IK08
Protection class	II
Risk group (EN 62471)	RG0
With control gear	Yes
Glow wire test	850°C
Power factor	≥ 0.9
Input wire diameter	1mm ² - 2.5mm ²

Electrical Supply

Frequency	50/60 Hz
Nominal voltage	220-240 V
DC input voltage	See catalogue appendix Connection Specifications

Mechanical Properties

Material housing	Polycarbonate
UV resistant	Yes
Optical material	Polycarbonate
Mounting clips	Stainless steel

Ambient Conditions

Operating temperature	-25-+45°C
Application temperature	+25°C
Storage environment	-25-+50°C



ENERGY

OPPLE Lighting
543022023700

A	▶
B	▶
C	▶
D	▶
E	▶
F	▶
G	▶

D

31
kWh/1000h

2019/2015

Dimensional Drawing (mm)

LEDWaterproof-P3 L1610

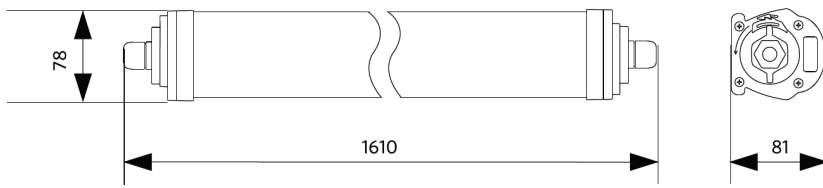

Installation Possibilities

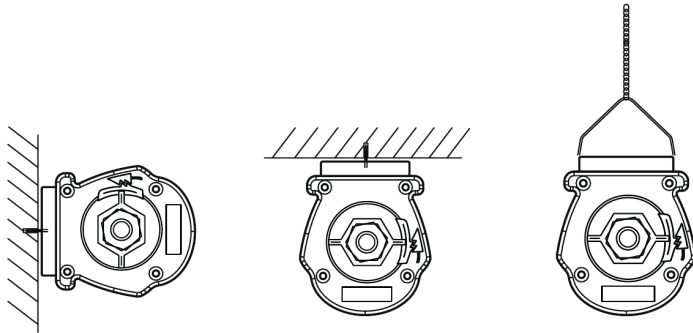

Photometric Data

