



Roadlight Stratus

- Easy installation and maintenance via openable driver compartment
- Flexible and adjustable pole connector (60mm & 76mm) for both side entry and pole top mounting (order separately)



Specifications

Item Code	Item Description	Equivalent to (W)	Power (W)	Lumen	Efficacy (lm/W)	CCT (K)	Beam angle	Weight (kg/pc)
On-Off								
705000095900	LEDRoad-St-P2 Re488-20W-740	HID 50W	20	3000	150	4000	143° x 70°	4.10

Accessories



705098008300
Pole Adapter-Road-St-P2-60mm



705098008400
Pole Adapter-Road-St-P2-76mm



705098003600
LEDStreetlight Wall-Bracket-60



705098003700
LEDStreetlight Pole-Top-60-Adapter-60



705098003400
LEDStreetlight Pole-Top-76-Adapter-60



705098005500
LEDStreetlight Pole-Top-60-Adapter-2x60

Packaging Information

Item			Box			
Item Code	Item Description	EU HS Code	Dimensions (mm) (LxWxH)	Gross Weight (kg)	EAN	pc/box
705000095900	LEDRoad-St-P2 Re488-20W-740	94054239	545x285x145	5.00	6941497780690	1
705098003400	LEDStreetlight Pole-Top-76-Adapter-60	94059900	223x116x314	1.94	6941497755100	1
705098003600	LEDStreetlight Wall-Bracket-60	94059900	201x78x239	1.14	6941497755124	1
705098003700	LEDStreetlight Pole-Top-60-Adapter-60	94059900	215x97x301	1.62	6941497755117	1
705098005500	LEDStreetlight Pole-Top-60-Adapter-2x60	94059900	505x97x230	1.51	6941491705491	1
705098008300	Pole Adapter-Road-St-P2-60mm	94059900	140x94x201	0.85	6941497769312	1
705098008400	Pole Adapter-Road-St-P2-76mm	94059900	140x114x213	0.90	6941497769329	1

Technical Specifications	
Lifetime (L80)	100,000 h
On-/Off-cycles	100,000
Colour consistency (SDCM)	5
Dimmability	On-Off
Maximum tilt angle	-15-+15°
Finishing	Grey RAL 870-3
Colour rendering index (CRI)	> 70
Degree of protection (IP)	IP66
Impact strength	IK08
Protection class	II (I on request)
Risk group (EN 62471)	RG0
With control gear	Yes
Glow wire test	850°C
Power factor	≥ 0.9
Surge protection	10 kV

Electrical Supply	
Frequency	50/60 Hz
Nominal voltage	220-240 V
DC input voltage	No

Mechanical Properties	
Housing material	Aluminum
Optical material	Polycarbonate
Compatible pole Ø	48-76 mm
Effective wind area	1300 cm ²
Coastal proof	Yes

Ambient Conditions	
Operating temperature	-25-+45°C
Application temperature	+25°C
Storage environment	-40-+60°C



Dimensional Drawing (mm)

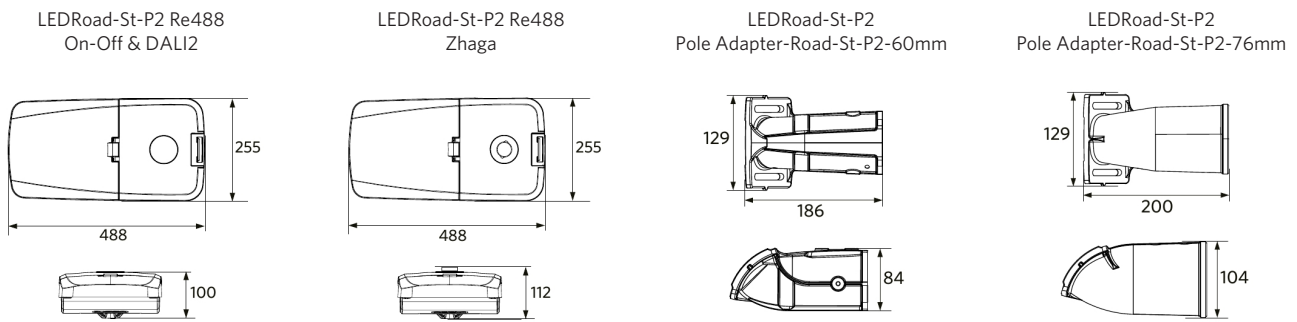

Photometric Data

