



Floodlight EcoMax G3

- Equipped with breather to prevent condensation



Specifications

Item Code	Item Description	Equivalent to (W)	Power (W)	Lumen	Efficacy (lm/W)	CCT (K)	With sensor	Degree of protection (IP)	Surge protection	Weight (kg/pc)
On-Off										
709000071500	LEDflood-E3 Re100-10W-830-BL	Halogen 50W	10	1100	110	3000	No	IP66	2 kV	0.40

Accessories



543098021900
LEDFixture-IP68-Connector-Kit-3



599000004600
LEDStreet-SE-ExtensionCable-6m

Packaging Information

Item		Box				
Item Code	Item Description	EU HS Code	Dimensions (mm) (LxWxH)	Gross Weight (kg)	EAN	pc/box
709000071500	LEDflood-E3 Re100-10W-830-BL	94054239	330x270x220	0.43	6941497776679	1
543098021900	LEDFixture-IP68-Connector-Kit-3	39174000	265x245x205	0.08	6941497708991	1
599000004600	LEDStreet-SE-ExtensionCable-6m	85444290	100x60x350	0.68	6956321815370	1

5 YEARS WARRANTY



Technical Specifications		Electrical Supply	
Lifetime (L70)	50,000 h	Frequency	50/60 Hz
Lifetime (L80)	30,000 h	Nominal voltage	220-240 V
On-/Off-cycles	100,000	DC input voltage	No
Colour consistency (SDCM)	4	230V Cable length	1 m
Dimmability	On-Off	Mechanical Properties	
Sensor type	No sensor	Housing material	Die-casted Aluminum
Sensor technology	No sensor	Optical material	Polycarbonate
Beam angle	100°	Cover material	Tempered glass
Finishing	Black	Coastal proof	Yes
Colour rendering index (CRI)	> 80	Ambient Conditions	
Impact strength	IK07	Operating temperature	-30-+50°C
Protection class	I	Operating temperature MD	n/a
Risk group (EN 62471)	RG1	Application temperature	+25°C
With control gear	Yes	Storage environment	-40-+60°C
Glow wire test	850°C		
Power factor	≥ 0.9		

Dimensional Drawing (mm)

LEDflood-E3 Re100
10W

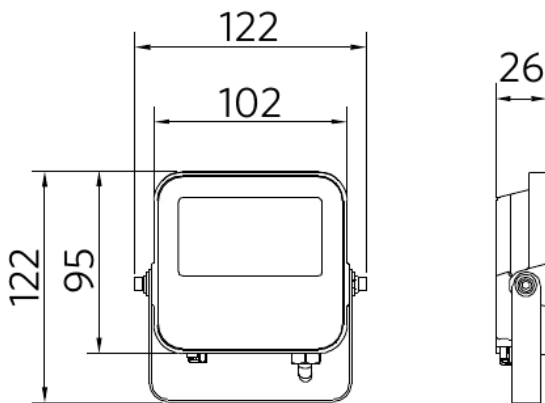

Photometric Data

