



## Floodlight EcoMax G3

- Complete floodlight family from 10 to 200W
- Equipped with breather to prevent condensation



## Specifications

Item Code	Item Description	Equivalent to (W)	Power (W)	Lumen (lm)	Efficacy (lm/W)	CCT (K)	Beam angle	Net Weight (kg/pc)
709000072100	LEDflood-E3 Re100-10W-840-WH	Halogen 50W	10	1200	120	4000	100°	0.4

## Accessories



543098021900  
LEDFixture-IP68-  
Connector-Kit-3



705000141900  
LEDStreet-SE-  
ExtensionCable-6m

## Packaging information

Item			Box			
Item Code	Item Description	EU HS Code	Dimensions (mm) (LxWxH)	Gross Weight (kg/pc)	EAN	pc/box
709000072100	LEDflood-E3 Re100-10W-840-WH	94054239	330x330x220	0.43	6941497776617	1
543098021900	LEDFixture-IP68-Connector-Kit-3	39174000	265x245x205	0.08	6941497708991	1
705000141900	LEDStreet-SE-ExtensionCable-6m	85444290	100x60x350	0.68	6941491727738	1



Technical Specifications	
Lifetime (L70)	50,000 h
Lifetime (L80)	30,000 h
On-/Off-cycles	100,000
Colour consistency (SDCM)	4
Dimmability	On-Off
Sensor type	No sensor
Sensor technology	No sensor
Colour rendering index (CRI)	> 80
Ingress Protection (IP)	IP66
Impact strength (IK)	IK07
Protection class	I
Risk group (EN 62471)	RG1
With control gear	True
Glow wire test	850 °C
Driver failure rate (at 5,000 hrs)	≤ 0.5 %
Power factor	≥ 0.9
Surge protection (kV)	2 kV

Electrical Supply	
Frequency	50 - 60 Hz
Nominal voltage	220 - 240 V
DC input voltage	No
230V Cable length	1 m

Mechanical Properties	
Housing material	Aluminium
Optical material	Polycarbonate
Cover material	Tempered glass
Coastal proof	Yes

Ambient Conditions	
Operating temperature	-30 ~ 50 °C
Application temperature	25 °C
Storage environment	-40 ~ 60 °C

## Dimensional Drawing (mm)

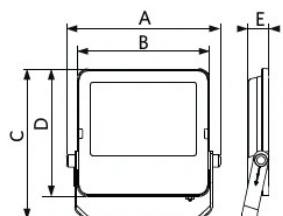

Type	A	B	C	D	E
Re100	122	102	122	95	26
Re115	138	115	137	108	28
Re144 MD	172	142	218	133	34
Re144	172	142	170	133	34
Re170	200	172	207	165	32
Re246	286	245	280	236	40
Re300	350	298	335	288	45
Re345	400	345	380	333	50

# Photometric Data

