



Waterproof Performer G4

- Powerful range of waterproof luminaires in specific "sealed for life" design
- Quick installation thanks to its screwless endcap
- Supplied with vandal-proof stainless steel ceiling and suspension clips



Specifications

Item Code	Item Description	Equivalent to (W)	Power (W)	Lumen	Efficacy (lm/W)	CCT (K)	Internal wiring (mm ²)	Max. input cable diameter (mm)	Weight (kg/pc)
Smart									
711000006900	LEDWaterproof-P4 L1489-51W-BLE2-840	TL 2x58W	51	7650	150	4000	3x2.5	7-11	1.21

Packaging Information

Item			Box			
Item Code	Item Description	EU HS Code	Dimensions (mm) (LxWxH)	Gross Weight (kg)	EAN	pc/box
711000006900	LEDWaterproof-P4 L1489-51W-BLE2-840	94051190	1497x70x80	1.50	6931783015148	1
560006000900	LEDSmart-Sensor IP65-Base-Module	94059200	140x140x150	0.56	6941497726063	1
560006001000	LEDSmart-Sensor IP65-Module	94059200	145x120x150	0.55	6941497726056	1
560098000600	LEDSmart-Sensor Surface-Module-WH	94059200	330x220x255	0.15	6941497703972	1
821006001800	LEDSmart-BLE2-Rc-MW-Sensor	85365005	100x100x130	0.19	6941497778277	1
821006002000	LEDSmart-BLE2-Rc-PIR-Sensor	85365005	100x100x70	0.19	6941497778260	1
821009000200	LEDSmart-BLE2-Switch	85365005	89x21x101	0.10	6941497778253	1
821011002600	LEDSmart-BLE2-DALI-Connect-Box	85176200	100x60x105	0.30	6941497778291	1
821017003400	LEDSmart-BLE2-Multi-Switch-Module	94059200	46x46x30	0.07	6931783007600	1
821017003800	LEDSmart-BLE2-Relay-1000W	85364900	110x57x37	0.10	6941497778284	1

Technical Specifications	
Lifetime (L70)	100,000 h
Lifetime (L80)	80,000 h
On-/Off-cycles	100,000
Colour consistency (SDCM)	4
Dimmability	BLE2
Beam angle	120°
Finishing	Grey RAL 7035
Colour rendering index (CRI)	> 80
Degree of protection (IP)	IP66
Impact strength	IK08
Protection class	II
Risk group (EN 62471)	RG0
With control gear	Yes
Glow wire test	850°C
Power factor	≥ 0.9
Input wire diameter	1mm ² - 2.5mm ²

Electrical Supply	
Frequency	50/60 Hz
Nominal voltage	220-240 V
DC input voltage	See catalogue appendix Connection Specifications

Mechanical Properties	
Material housing	Polycarbonate
UV resistant	Yes
Optical material	Polycarbonate
Mounting clips	Stainless steel

Ambient Conditions	
Operating temperature	-30~+45°C
Application temperature	+25°C
Storage environment	-30~+50°C

5 YEARS WARRANTY



Dimensional Drawing (mm)

LEDWaterproof-P4 L1489

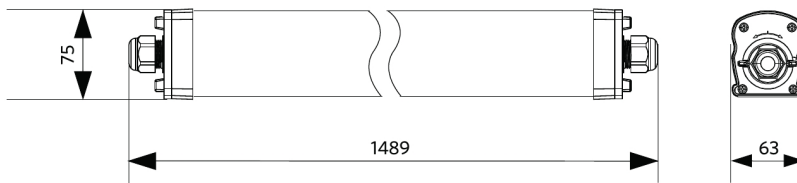

Installation Possibilities

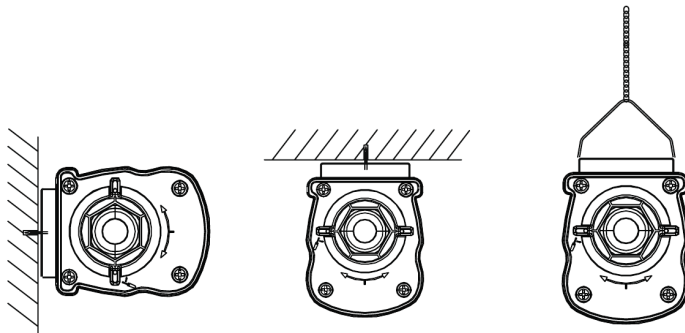

Photometric Data

