



Waterproof Performer G4

- Powerful range of waterproof luminaires in specific "sealed for life" design
- Quick installation thanks to its screwless endcap
- Supplied with vandal-proof stainless steel ceiling and suspension clips



Specifications

Item Code	Item Description	Equivalent to (W)	Power (W)	Lumen	Efficacy (lm/W)	CCT (K)	Internal wiring (mm ²)	Max. input cable diameter (mm)	Weight (kg/pc)
Emergency version 1 hour, On-Off									
711000010400	LEDWaterproof-P4 L1489-31W-840-PLUS-EM1	TL 1x58W	31	4650	150	4000	5x2.5	8-14	2.11

Packaging Information

Item				Box			
Item Code	Item Description	EU HS Code	Dimensions (mm) (LxWxH)	Gross Weight (kg)	EAN	pc/box	
711000010400	LEDWaterproof-P4 L1489-31W-840-PLUS-EM1	94051190	1497x70x80	2.40	6931783014790	1	

Technical Specifications

Lifetime (L70)	100,000 h
Lifetime (L80)	80,000 h
On-/Off-cycles	100,000
Colour consistency (SDCM)	4
Dimmability	On-Off
Beam angle	120°
Finishing	Grey RAL 7035
Colour rendering index (CRI)	> 80
Degree of protection (IP)	IP66
Impact strength	IK08
Protection class	II
Risk group (EN 62471)	RGO
With control gear	Yes
Glow wire test	850°C
Power factor	≥ 0.9
Input wire diameter	1mm ² - 2.5mm ²

Electrical Supply

Frequency	50/60 Hz
Nominal voltage	220-240 V
DC input voltage	See catalogue appendix Connection Specifications

Mechanical Properties

Material housing	Polycarbonate
UV resistant	Yes
Optical material	Polycarbonate
Mounting clips	Stainless steel

Ambient Conditions

Operating temperature	-30-+45°C
Application temperature	+25°C
Storage environment	-30-+50°C

5 YEARS WARRANTY



Dimensional Drawing (mm)

LEDWaterproof-P4 L1489

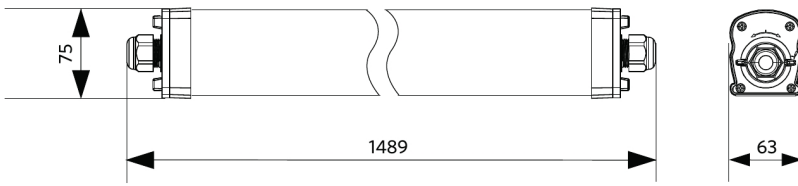

Installation Possibilities

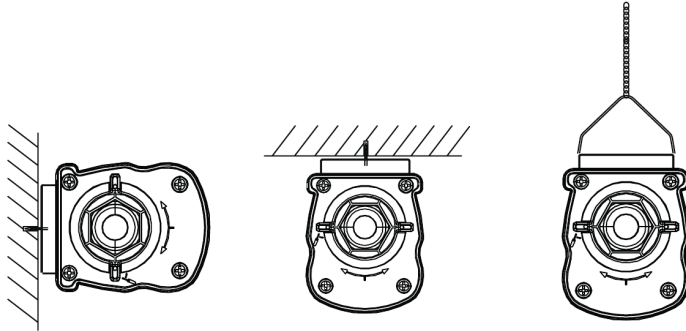

Photometric Data

