



Downlight Performer HG

- LED downlight sophistiqué, de qualité supérieure
- Concept optique unique
- Hauteur lumineuse max 73mm
- Remplacement direct des lampes fluo-compactes
- IP44 côté utilisateur
- Film de protection a laisser durant le chantier



Caractéristiques

Code d'article	Désignation d'article	Equivalent (W)	Puissance (W)	Lumens	Rendement (lm/W)	UGR	CCT (K)	IRC	Poids brut (kg/pc)
Smart									
540001334500	LEDDownlightRc-P-HG R200-33W-BLE2-3000	CFL 2x32W	33	3560	108	≤22	3000	> 80	0,84

Accessoires



140060647
LEDDownlightRc-P-SI-E-Adapter-200-225



140061243
LEDDownlightRc-P-R200-Surface-Module-WH



549098001300
LEDDownlightRc-P EM-kit 1h



542098030700
Junction-Box-WH

140060648
LEDDownlightRc-P-SI-E-Adapter-200-250

549098001400
LEDDownlightRc-P EM-kit 3h

Info d'article et emballage

Article			Emballage			
Code d'article	Désignation d'article	EU HS Code	Dimensions (mm) (HxLxL)	Poids brut (kg)	EAN	pc par boîte
540001334500	LEDDownlightRc-P-HG R200-33W-BLE2-3000	94051190	260x260x118	1,21	6931783010464	1
140060647	LEDDownlightRc-P-SI-E-Adapter-200-225	94059900	250x250x0.8	0,23	6956321894139	1
140060648	LEDDownlightRc-P-SI-E-Adapter-200-250	94059900	275x275x0.8	0,20	6956321894146	1
140061243	LEDDownlightRc-P-R200-Surface-Module-WH	94059900	277x277x240	2,66	6956321841416	1
542098030700	Junction-Box-WH	85369010	43x103.4x26	0,06	6941408868684	1
549098001300	LEDDownlightRc-P EM-kit 1h	85044083	490x390x150	0,98	6941497709592	1
549098001400	LEDDownlightRc-P EM-kit 3h	85044083	490x390x150	1,08	6941497709585	1
560098000600	LEDSmart-Sensor Surface-Module-WH	94059200	330x220x255	0,15	6941497703972	1
821006001800	LEDSmart-BLE2-Rc-MW-Sensor	85365005	100x100x130	0,19	6941497778277	1
821006002000	LEDSmart-BLE2-Rc-PIR-Sensor	85365005	100x100x70	0,19	6941497778260	1
821009000200	LEDSmart-BLE2-Switch	85365005	89x21x101	0,10	6941497778253	1
821011002600	LEDSmart-BLE2-DALI-Connect-Box	85176200	100x60x105	0,30	6941497778291	1
821017003400	LEDSmart-BLE2-Multi-Switch-Module	94059200	46x46x30	0,07	6931783007600	1
821017003800	LEDSmart-BLE2-Relay-1000W	85364900	110x57x37	0,10	6941497778284	1

Caractéristiques	
Durée de vie (L70)	70.000 h
Durée de vie (L80)	50.000 h
Cycles marche/arrêt	100.000
Cohérence de couleur (SDCM)	3
Gradabilité	BLE2
Angle de faisceau	70°
Couleur de finition	Blanc RAL9003
IP côté utilisateur	IP44
IP partie encastrée	IP20
IK	IK02
Classe de protection	II
Groupe de risque (EN 62471)	RG0 / RG1 (23W & 33W)
Pilote inclus (Oui/Non)	Oui
Essai au fil incandescent	650°C
Facteur de puissance	≥ 0,9

Alimentation électrique	
Fréquence	50/60 Hz
Tension AC	220-240 V
DC input voltage	Voir annexe du catalogue Connection Caractéristiques
Longueur de câble 230V	0.3 m

Propriétés mécaniques	
Structure	Aluminium
Matériau optique	Polycarbonate

Conditions d'application	
Température de fonctionnement	-10-+40°C
Température d'application	+25°C
Environnement de stockage	-25-+50°C

5 ANS DE GARANTIE



ENERGY

OPPLE Lighting
540001334500

33
kWh/1000h

2019/2015

Schéma de dimensions (mm)

LEDDownlight Driver

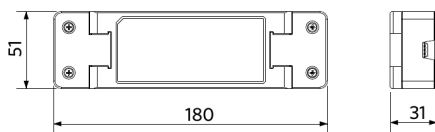

LEDDownlightRc-P-HG R200

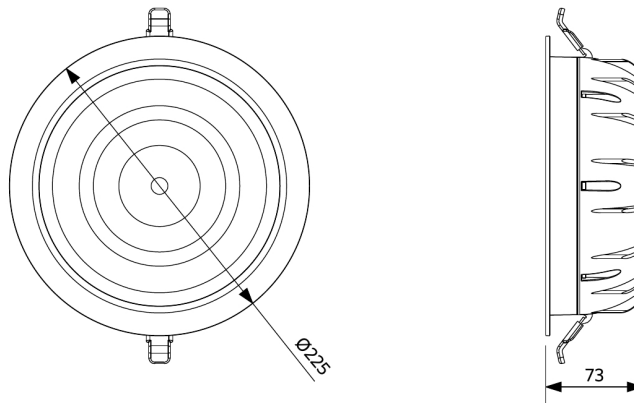

LEDDownlight Driver Tunable White

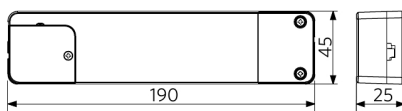

LEDDownlightRc-P-HG R200
LEDDownlightRc-P-R200-Surface-Module

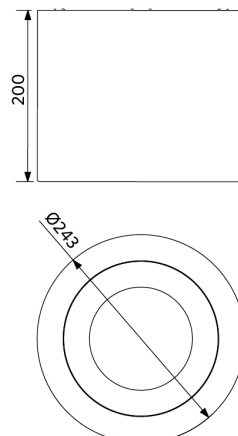

Données photométriques

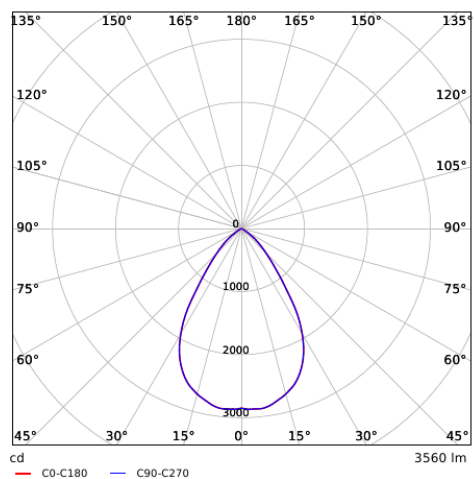

Schémas diamètre d'encastement (mm)

LEDDownlightRc-P-HG R200
Ø200

