



Roadlight Stratus

- Installation et maintenance aisées grâce au compartiment driver ouvrable
- Connecteur de poteau flexible et réglable (60 mm et 76 mm) pour une entrée latérale ou un montage du poteau (à commander séparément)



Caractéristiques

Code d'article	Désignation d'article	Equivalent (W)	Puissance (W)	Lumens	Rendement (lm/W)	CCT (K)	Angle de faisceau	Poids brut (kg/pc)
Marche-Arrêt								
705000099000	LEDRoad-St-P2 Re488-20W-740-XAS	HID 50W	20	3000	150	4000	160° x 93°	4,10

Accessoires



705098008300
Pole Adapter-Road-St-P2-60mm



705098008400
Pole Adapter-Road-St-P2-76mm



705098003600
LEDStreetlight Wall-Bracket-60



705098003700
LEDStreetlight Pole-Top-60-Adapter-60



705098003400
LEDStreetlight Pole-Top-76-Adapter-60



705098005500
LEDStreetlight Pole-Top-60-Adapter-2x60

Info d'article et emballage

Article			Emballage			
Code d'article	Désignation d'article	EU HS Code	Dimensions (mm) (HxIxL)	Poids brut (kg)	EAN	pc par boîte
705000099000	LEDRoad-St-P2 Re488-20W-740-XAS	94054239	545x285x145	5,00	6941497780812	1
705098003400	LEDStreetlight Pole-Top-76-Adapter-60	94059900	223x116x314	1,94	6941497755100	1
705098003600	LEDStreetlight Wall-Bracket-60	94059900	201x78x239	1,14	6941497755124	1
705098003700	LEDStreetlight Pole-Top-60-Adapter-60	94059900	215x97x301	1,62	6941497755117	1
705098005500	LEDStreetlight Pole-Top-60-Adapter-2x60	94059900	505x97x230	1,51	6941491705491	1
705098008300	Pole Adapter-Road-St-P2-60mm	94059900	140x94x201	0,85	6941497769312	1
705098008400	Pole Adapter-Road-St-P2-76mm	94059900	140x114x213	0,90	6941497769329	1

Caractéristiques	
Durée de vie (L80)	100.000 h
Cycles marche/arrêt	100.000
Cohérence de couleur (SDCM)	5
Gradabilité	On-Off
Angle d'inclinaison maximum	-15-+15°
Couleur de finition	Gris RAL 870-3
IRC	> 70
IP	IP66
IK	IK08
Classe de protection	II (I sur demande)
Groupe de risque (EN 62471)	RG0
Pilote inclus (Oui/Non)	Oui
Essai au fil incandescent	850°C
Facteur de puissance	≥ 0,9
Surtension	10 kV

Alimentation électrique	
Fréquence	50/60 Hz
Tension AC	220-240 V
DC input voltage	Non



Propriétés mécaniques	
Structure	Aluminium
Matériau optique	Polycarbonate
Compatible poteau Ø	48-76 mm
Charge de vent efficace	1300 cm ²
Résistant à la corrosion côtière	Oui

Conditions d'application	
Température de fonctionnement	-25-+45°C
Température d'application	+25°C
Environnement de stockage	-40-+60°C

Schéma de dimensions (mm)

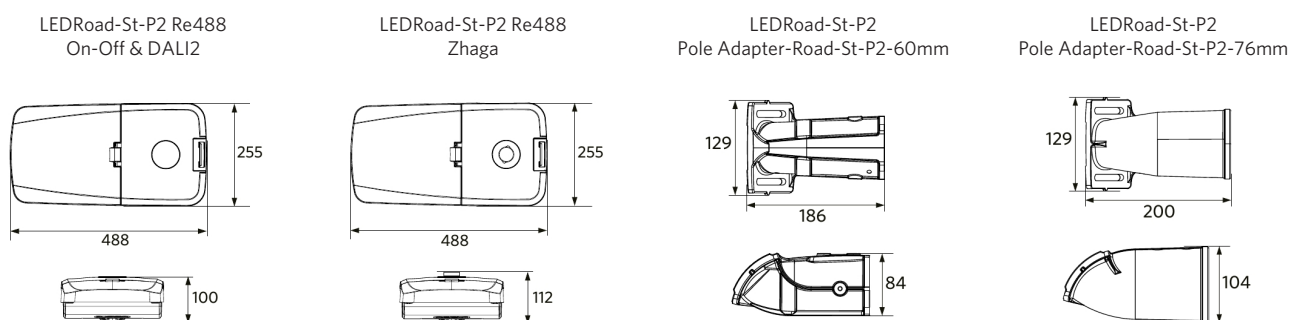

Données photométriques

