

Waterdichtarmatuur Waterproof Performer G4

- Krachtig assortiment waterdichte armaturen in specifiek "sealed for life"-ontwerp
- Eenvoudig installeren dankzij schroefloze snelsluiting
- Geleverd met vandaalbestendige RVS montageklemmen



Specificaties

Artikelcode	Artikelomschrijving	Equivalent (W)	Vermogen (W)	Lumen	Efficiëntie (lm/W)	CCT (K)	Interne bedrading (mm ²)	Max. diameter invoerkabel (mm)	Gewicht (kg/st)
Smart									
711000007100	LEDWaterproof-P4 L1489-31W-BLE2-840	TL 1x58W	31	4650	150	4000	3x2.5	7-11	1,21

Artikel- en verpakkingsinformatie

Artikel			Doosverpakking			
Artikelcode	Artikelomschrijving	EU HS Code	Afmetingen (mm) (LxBxH)	Brutogewicht (kg)	EAN	st/doos
711000007100	LEDWaterproof-P4 L1489-31W-BLE2-840	94051190	1497x70x80	1,50	6931783015124	1
560006000900	LEDSmart-Sensor IP65-Base-Module	94059200	140x140x150	0,56	6941497726063	1
560006001000	LEDSmart-Sensor IP65-Module	94059200	145x120x150	0,55	6941497726056	1
560098000600	LEDSmart-Sensor Surface-Module-WH	94059200	330x220x255	0,15	6941497703972	1
821006001800	LEDSmart-BLE2-Rc-MW-Sensor	85365005	100x100x130	0,19	6941497778277	1
821006002000	LEDSmart-BLE2-Rc-PIR-Sensor	85365005	100x100x70	0,19	6941497778260	1
821009000200	LEDSmart-BLE2-Switch	85365005	89x21x101	0,10	6941497778253	1
821011002600	LEDSmart-BLE2-DALI-Connect-Box	85176200	100x60x105	0,30	6941497778291	1
821017003400	LEDSmart-BLE2-Multi-Switch-Module	94059200	46x46x30	0,07	6931783007600	1
821017003800	LEDSmart-BLE2-Relay-1000W	85364900	110x57x37	0,10	6941497778284	1

Technische specificaties

Levensduur (L70)	100.000 u
Levensduur (L80)	80.000 u
Aan-/Uit-cycli	100.000
Kleurconsistentie (SDCM)	4
Dimbaarheid	BLE2
Bundelhoek	120°
Afwerking	Grijs RAL 7035
CRI	> 80
Beschermingsgraad (IP)	IP66
Slagvastheid	IK08
Beschermingsklasse	II
Risicogroep (EN 62471)	RGO
Voorschakelapparaat inbegrepen	Ja
Gloeidraadtest	850°C
Vermogensfactor	≥ 0,9
Diameter van ingangsdraad	1mm ² - 2.5mm ²

Elektrische aansluiting

Frequentie	50/60 Hz
Nom. spanning	220-240 V
DC ingangsspanning	Zie catalogusbijlage Aansluitwaarden

Materiaal eigenschappen

Materiaal behuizing	Polycarbonaat
UV-bestendig	Ja
Materiaal optiek	Polycarbonaat
Bevestigingsclips	Roestvaststaal (RVS)

Toepassingscondities

Bedrijfstemperatuur	-30~+45°C
Gebruikstemperatuur	+25°C
Opslagtemperatuur	-30~+50°C

5 JAAR GARANTIE



Maatschets (mm)

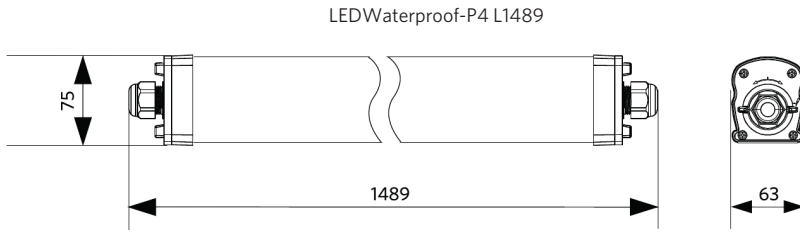

Installatiemogelijkheden

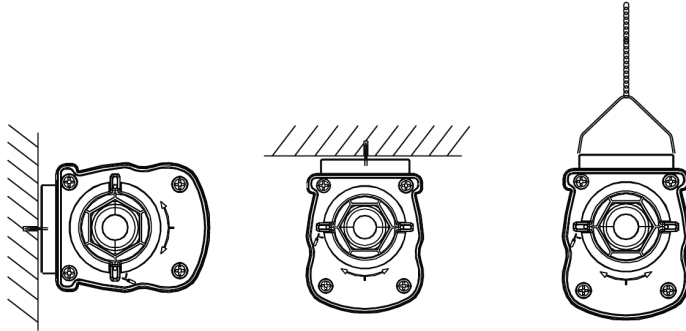

Fotometrische gegevens

