



Downlight Compact

- Stijlvolle en compacte LED downlight
- Stevige volledig metalen behuizing
- Geïntegreerde driver voor eenvoudigere installatie
- Geringe hoogte van slechts 35 mm
- Hoge efficiëntie tot 100 lm/W
- IP44 (lichtuitvoerkant)
- Volledig gamma: 4 vermogens en 4 inbouwmaten



Specificaties

Artikelcode	Artikelomschrijving	Equivalent (W)	Vermogen (W)	Lumen	Efficiëntie (lm/W)	CCT (K)	Gewicht (kg/st)
Statisch							
540001290900	LEDDownlightCo-E Rd100-9W-830	CFL 1x18W	9	810	90	3000	0,12
540001291000	LEDDownlightCo-E Rd100-9W-840	CFL 1x18W	9	855	95	4000	0,12
540001291100	LEDDownlightCo-E Rd125-14W-830	CFL 1x26W	14	1190	85	3000	0,14
540001291200	LEDDownlightCo-E Rd125-14W-840	CFL 1x26W	14	1260	90	4000	0,14
540001291300	LEDDownlightCo-E Rd150-18W-830	CFL 1x26W	18	1620	90	3000	0,20
540001291400	LEDDownlightCo-E Rd150-18W-840	CFL 1x26W	18	1710	95	4000	0,20
540001291500	LEDDownlightCo-E Rd200-24W-830	CFL 2x26W	24	2280	95	3000	0,32
540001291600	LEDDownlightCo-E Rd200-24W-840	CFL 2x26W	24	2400	100	4000	0,32

Accessoires



140060650
LEDDownlightRc-HZdim-
Adapter-125-150



542098030700
Junction-Box-WH

140060646
LEDDownlightRc-P-HZ-
Adapter-150-175

Zie de bijlage Overzicht adapterringen voor de maatschetsen van de adapterringen.

5 JAAR GARANTIE



Technische specificaties	
Levensduur (L70)	50.000 u
Levensduur (L80)	30.000 u
Aan-/Uit-cycli	100.000
Kleurconsistentie (SDCM)	3
Dimbaarheid	On-Off
Bundelhoek	100°
Afwerking	Wit RAL9003
CRI	> 80
IP voorzijde	IP44
IP-klasse achterzijde	IP20
Slagvastheid	IK02
Beschermingsklasse	II
Risicogroep (EN 62471)	RG0
Voorschakelapparaat inbegrepen	Ja
Gloeidraadtest	650°C
Verplaatsingsfactor	≥ 0.9

Elektrische aansluiting	
Frequentie	50/60 Hz
Nom. spanning	220-240 V
DC ingangsspanning	Nee
230V Kabellengte	0.3 m

Materiaal eigenschappen	
Materiaal behuizing	Aluminium
Materiaal optiek	Polycarbonaat

Toepassingscondities	
Bedrijfstemperatuur	-10-+45°C
Gebruikstemperatuur	+25°C
Opslagtemperatuur	-25-+45°C

Maatschets (mm)

LEDDownlightCo-E Rd100

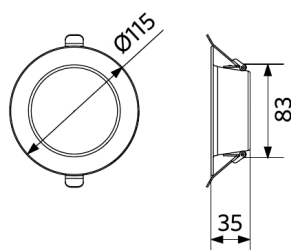

LEDDownlightCo-E Rd125

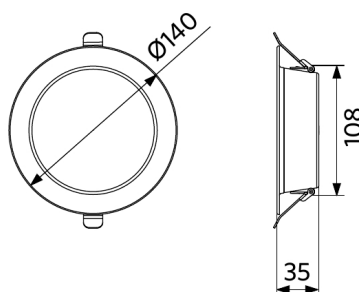

LEDDownlightCo-E Rd150

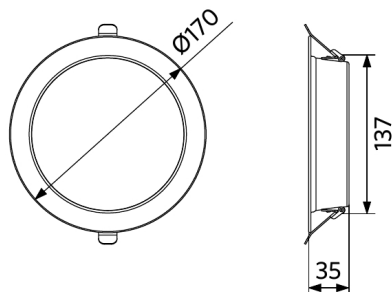

LEDDownlightCo-E Rd200

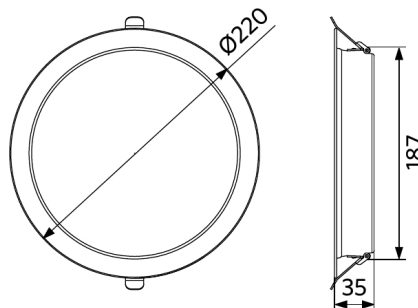

Tekening inbouwmaat (mm)

LEDDownlightCo-E Rd100
Ø100

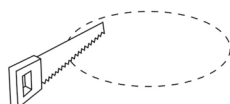

LEDDownlightCo-E Rd125
Ø125

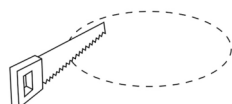

LEDDownlightCo-E Rd150
Ø150

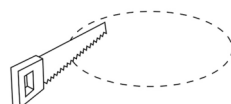

LEDDownlightCo-E Rd200
Ø200

