

## LED Linear Highbay

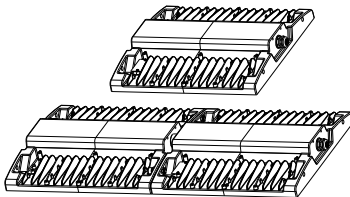

Model name

CCT







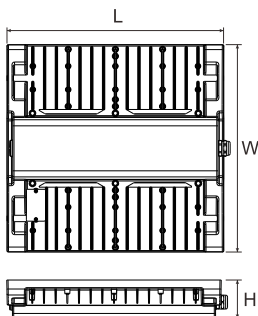

Model name	CCT	KG
LED HB-Lin-P 150W-DALI-X	4000K	4.4KG
LED HB-Lin-P 150W-DALI-X-EM1	4000K	5.0KG
LED HB-Lin-P 240W-DALI-X	4000K	7.6KG
LED HB-Lin-P 240W-DALI-X-EM3	4000K	8.6KG
LED HB-Lin-P 300W-DALI-X	4000K	8.1KG
LED HB-Lin-P 300W-DALI-X-EM3	4000K	9.1KG

Note: X stands for N,W,AS,XAS



Model name	Size(LxWxH)mm	Current(A)	Rated Power(W)
LED HB-Lin-P 150W-DALI-X	340x325x60	0.69	150W
LED HB-Lin-P 150W-DALI-X-EM1	340x325x60	0.69	150W
LED HB-Lin-P 240W-DALI-X	680x325x60	1.10	240W
LED HB-Lin-P 240W-DALI-X-EM3	680x325x60	1.10	240W
LED HB-Lin-P 300W-DALI-X	680x325x60	1.38	300W
LED HB-Lin-P 300W-DALI-X-EM3	680x325x60	1.38	300W

Note: X stands for N,W,AS,XAS

Product Code	Product Description	N	Light Source Code	QR Code	Energy Label
545001106700	LEDHighbay-Lin-P 150W-DALI-840-N	1	LS099015015		
545001107300	LEDHighbay-Lin-P 150W-DALI-840-W				
545001107900	LEDHighbay-Lin-P 150W-DALI-840-AS				
545001108500	LEDHighbay-Lin-P 150W-DALI-840-XAS				
545001109100	LEDHighbay-Lin-P 150W-DALI-840-N-EM1				
545001109700	LEDHighbay-Lin-P 150W-DALI-840-W-EM1				
545001110300	LEDHighbay-Lin-P 150W-DALI-840-AS-EM1				
545001110900	LEDHighbay-Lin-P 150W-DALI-840-XAS-EM1				
545001106800	LEDHighbay-Lin-P 240W-DALI-840-N	1	LS099024015		
545001107400	LEDHighbay-Lin-P 240W-DALI-840-W				
545001108000	LEDHighbay-Lin-P 240W-DALI-840-AS				
545001108600	LEDHighbay-Lin-P 240W-DALI-840-XAS				
545001109200	LEDHighbay-Lin-P 240W-DALI-840-N-EM3				
545001109800	LEDHighbay-Lin-P 240W-DALI-840-W-EM3				
545001110400	LEDHighbay-Lin-P 240W-DALI-840-AS-EM3				
545001111000	LEDHighbay-Lin-P 240W-DALI-840-XAS-EM3				
545001106900	LEDHighbay-Lin-P 300W-DALI-840-N	1	LS099030015		
545001107500	LEDHighbay-Lin-P 300W-DALI-840-W				
545001108100	LEDHighbay-Lin-P 300W-DALI-840-AS				
545001108700	LEDHighbay-Lin-P 300W-DALI-840-XAS				
545001109300	LEDHighbay-Lin-P 300W-DALI-840-N-EM3				
545001109900	LEDHighbay-Lin-P 300W-DALI-840-W-EM3				
545001110500	LEDHighbay-Lin-P 300W-DALI-840-AS-EM3				
545001111100	LEDHighbay-Lin-P 300W-DALI-840-XAS-EM3				

## Installation

### A. Rotatable bracket mounting

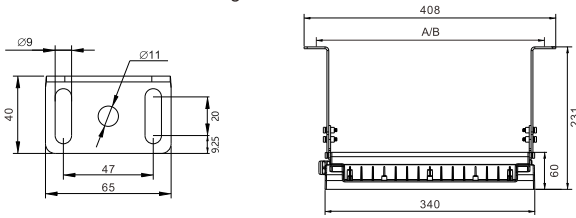

#### Reference spacing dimension

A (150W)	370mm
B (240W/300W)	710mm

①

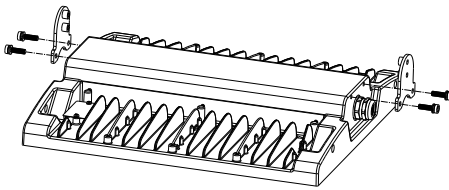

②

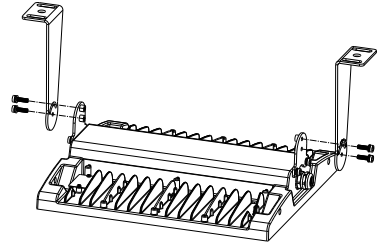

③

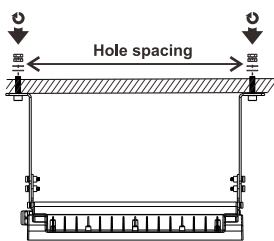

④

Rotatable angle

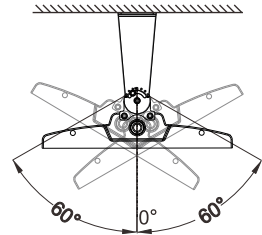

### B. Bracket mounting

①

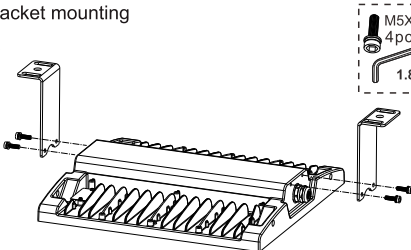

②

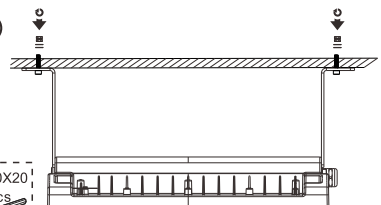

## C. Suspension mounting

1.

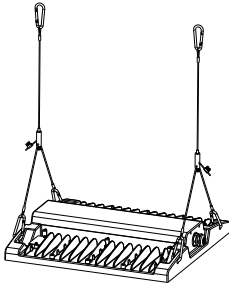

2.

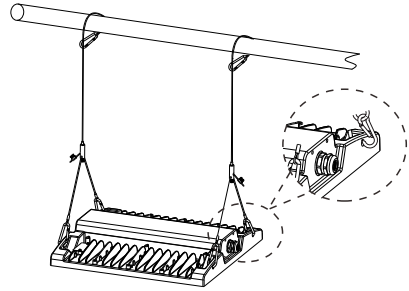

3.

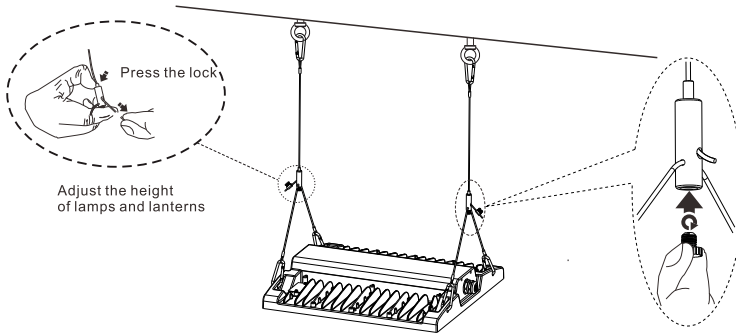

Caution: Any operation on LED module is forbidden while power-on.  
Zur Vermeidung von Risiken müssen defekte Leitungen ausschließlich vom Hersteller, Inverkehrbringer oder Fachmann ausgetauscht werden.  
Achtung: In Betrieb ist keine Arbeit am LED-Modul erlaubt.



For non-user replaceable light sources:  
The light source contained in this luminaire shall only be replaced by the manufacturer or his service agent or a similar qualified person.  
Das Leuchtmittel dieser Leuchte ist nicht austauschbar. Wenn das Leuchtmittel das Ende seiner Lebensdauer erreicht hat, muss die gesamte Leuchte ersetzt werden.



For use in environments where normal non-conductive/conductive dust accumulation may be expected, not for use in environments with expected high/unusual dust accumulation.



Data subject to change  
Les données sont sujettes à modifications  
Änderungen vorbehalten

Opple Lighting Electronic (Zhongshan) Co.,Ltd.  
Building A, No.275 Dongan Bei Road, Haizhou District,  
Guzhen Town, Zhongshan City, Guangdong Province, P.R.China

Opple Lighting B.V.  
Meerenakkerweg 1-07  
5652 AR Eindhoven  
The Netherlands  
service@opple.com  
www.opple.com