



## Downlight Slim EcoMax G2

- Slanke LED Downlight
- Flexibel door CCT schakelaar en Power schakelaar
- 5 lumenpakketten beschikbaar in 5 diameters (100mm tot 200mm)
- Zeer plat ontwerp, slechts 34 mm hoog
- IP44 aan lichtuitvoerkant



## Specificaties

Artikelcode	Artikelomschrijving	Equivalent (W)	Vermogen (W)	Lumen	Efficiëntie (lm/W)	CCT (K)	Nettogewicht (kg/st)
<b>Aan-Uit</b>							
540001365500	LEDDownlightS-E2 Rd175-15W-830/840-WH	CFL 1x26W	15	1725	115	3K/4K	0.43

Verkrijgbaar op aanvraag met Wieland GST18- of WAGO WINSTA-connector of Euro-/Schuko-stekker.

## Artikel- en verpakkingsinformatie

Item			Doos			
Artikelcode	Artikelomschrijving	EU HS-code	Afmetingen (mm) (LxBxH)	Brutogewicht (kg/st)	EAN	st/doos
540001365500	LEDDownlightS-E2 Rd175-15W-830/840-WH	94051190	188x188x70	0.55	6941491723624	1
140060651	LEDDownlightRc-HZdim-Adapter-175-200	94059900	230x230x20	0.20	6956321894177	1

Technische specificaties	
Levensduur (L70)	50.000 h
Levensduur (L80)	30.000 h
Aan-/Uit-cycli	100.000
Kleurconsistentie (SDCM)	4
Dimbaarheid	On-Off
Bundelhoek	100 °
Afwerking	Wit RAL9003
RAL-Nummer	9003
Kleurweergave index (CRI)	> 80
Beschermingsgraad voorzijde (IP)	IP44
Beschermingsgraad achterzijde (IP)	IP20
Slagvastheid (IK)	IK02
Beschermingsklasse	II
Risicogroep (EN 62471)	RG0
Voorschakelapparaat inbegrepen	Ja
Gloeidraadtest	650 °C
Percentage uitval driver (na 5,000 uur)	≤ 1 %
Displacement factor (DF)	≥ 0.9

Elektrische aansluiting	
Frequentie	50 - 60 Hz
Nominale spanning	220 - 240 V
DC ingangsspanning	Nee
230V Kabellengte	0,3 m

Materiaal eigenschappen	
Materiaal behuizing	Staal
Materiaal optiek	Polycarbonaat

Toepassingscondities	
Bedrijfstemperatuur	-10 ~ 45 °C
Gebruikstemperatuur	25 °C
Opslagtemperatuur	-25 ~ 50 °C

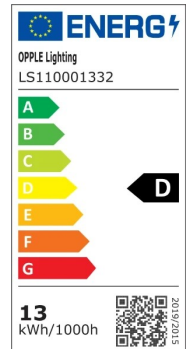

## Maatschets (mm)

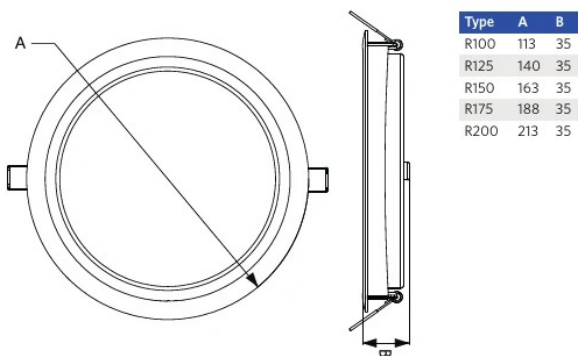

## Tekening inbouwmaat (mm)

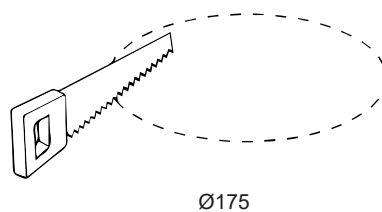
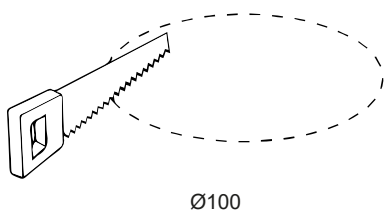
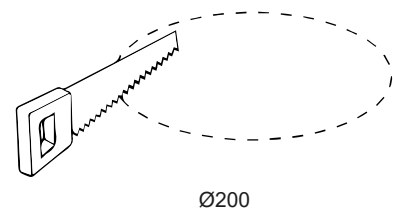
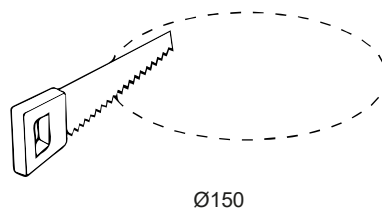
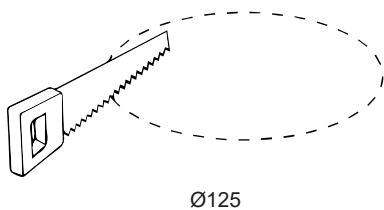

# Fotometrische gegevens

