

LED Highbay Performer G6

On/Off, BLE2, DALI

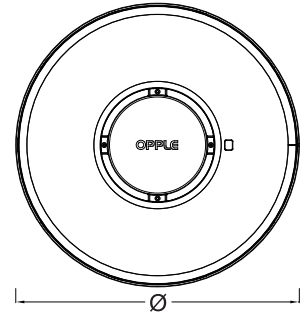

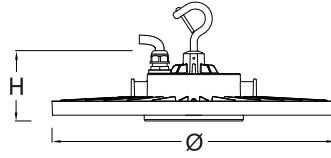

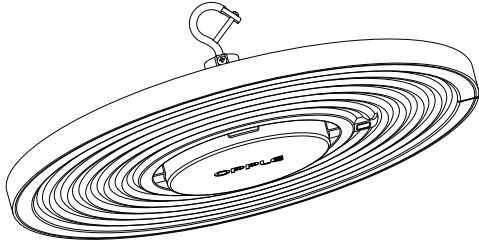































Technical Specification

Model	CCT	Weight (kg)	H(mm)	Φ(mm)
LED HB-P6 70W-X-840-Y	4000K	2.47	97	336
LED HB-P6 70W-X-857-Y	5700K	2.47	97	336
LED HB-P6 95W-X-840-Y	4000K	2.47	97	336
LED HB-P6 95W-X-857-Y	5700K	2.47	97	336
LED HB-P6 130W-X-840-Y	4000K	3.22	97	390
LED HB-P6 130W-X-857-Y	5700K	3.22	97	390
LED HB-P6 170W-X-840-Y	4000K	3.22	97	390
LED HB-P6 170W-X-857-Y	5700K	3.22	97	390
LED HB-P6 200W-X-840-Y	4000K	3.22	97	390
LED HB-P6 200W-X-857-Y	5700K	3.22	97	390

*Note: X stands for BLE2, DALI, or not available;
Y stands for N, W, AS.

Light Source

Product Code	Product Description	N	Light Source Code	QR Code	Energy Label
545001120400	LEDHighbay-P6 70W-840-AS	1	LS017007015-02		
545001114400	LEDHighbay-P6 70W-DALI-840-AS				
545001116800	LEDHighbay-P6 70W-BLE2-840-AS				
545001120200	LEDHighbay-P6 70W-840-N	1	LS017007015-03		
545001120300	LEDHighbay-P6 70W-840-W				
545001114200	LEDHighbay-P6 70W-DALI-840-N				
545001114300	LEDHighbay-P6 70W-DALI-840-W				
545001116600	LEDHighbay-P6 70W-BLE2-840-N				
545001116700	LEDHighbay-P6 70W-BLE2-840-W				
545001120700	LEDHighbay-P6 70W-857-AS				
545001114700	LEDHighbay-P6 70W-DALI-857-AS				
545001117100	LEDHighbay-P6 70W-BLE2-857-AS				
545001120500	LEDHighbay-P6 70W-857-N	1	LS017007018-03		
545001120600	LEDHighbay-P6 70W-857-W				
545001114500	LEDHighbay-P6 70W-DALI-857-N				
545001114600	LEDHighbay-P6 70W-DALI-857-W				
545001116900	LEDHighbay-P6 70W-BLE2-857-N				
545001117000	LEDHighbay-P6 70W-BLE2-857-W				
545001121000	LEDHighbay-P6 95W-840-AS				
545001115000	LEDHighbay-P6 95W-DALI-840-AS				
545001117400	LEDHighbay-P6 95W-BLE2-840-AS				
545001120800	LEDHighbay-P6 95W-840-N	1	LS017009515-03		
545001120900	LEDHighbay-P6 95W-840-W				
545001114800	LEDHighbay-P6 95W-DALI-840-N				
545001114900	LEDHighbay-P6 95W-DALI-840-W				
545001117200	LEDHighbay-P6 95W-BLE2-840-N				
545001117300	LEDHighbay-P6 95W-BLE2-840-W				
545001121300	LEDHighbay-P6 95W-857-AS				
545001115300	LEDHighbay-P6 95W-DALI-857-AS				
545001117700	LEDHighbay-P6 95W-BLE2-857-AS				
545001121100	LEDHighbay-P6 95W-857-N	1	LS017009518-03		
545001121200	LEDHighbay-P6 95W-857-W				
545001115100	LEDHighbay-P6 95W-DALI-857-N				
545001115200	LEDHighbay-P6 95W-DALI-857-W				
545001117500	LEDHighbay-P6 95W-BLE2-857-N				
545001117600	LEDHighbay-P6 95W-BLE2-857-W				
545001121600	LEDHighbay-P6 130W-840-AS				
545001115600	LEDHighbay-P6 130W-DALI-840-AS				
545001118000	LEDHighbay-P6 130W-BLE2-840-AS				
545001121400	LEDHighbay-P6 130W-840-N	1	LS017013015-03		
545001121500	LEDHighbay-P6 130W-840-W				
545001115400	LEDHighbay-P6 130W-DALI-840-N				
545001115500	LEDHighbay-P6 130W-DALI-840-W				
545001117800	LEDHighbay-P6 130W-BLE2-840-N				
545001117900	LEDHighbay-P6 130W-BLE2-840-W				

545001121900	LEDHighbay-P6 130W-857-AS	1	LS017013018-02		
545001115900	LEDHighbay-P6 130W-DALI-857-AS				
545001118300	LEDHighbay-P6 130W-BLE2-857-AS				
545001121700	LEDHighbay-P6 130W-857-N	1	LS017013018-03		
545001121800	LEDHighbay-P6 130W-857-W				
545001115700	LEDHighbay-P6 130W-DALI-857-N				
545001115800	LEDHighbay-P6 130W-DALI-857-W				
545001118100	LEDHighbay-P6 130W-BLE2-857-N				
545001118200	LEDHighbay-P6 130W-BLE2-857-W	1	LS017017015-02		
545001122200	LEDHighbay-P6 170W-840-AS				
545001116200	LEDHighbay-P6 170W-DALI-840-AS				
545001118600	LEDHighbay-P6 170W-BLE2-840-AS	1	LS017017015-03		
545001122000	LEDHighbay-P6 170W-840-W				
545001122100	LEDHighbay-P6 170W-840-N				
545001116000	LEDHighbay-P6 170W-DALI-840-N				
545001116100	LEDHighbay-P6 170W-DALI-840-W				
545001118400	LEDHighbay-P6 170W-BLE2-840-N	1	LS017017018-02		
545001118500	LEDHighbay-P6 170W-BLE2-840-W				
545001122500	LEDHighbay-P6 170W-857-AS				
545001116500	LEDHighbay-P6 170W-DALI-857-AS	1	LS017017018-03		
545001118900	LEDHighbay-P6 170W-BLE2-857-AS				
545001122300	LEDHighbay-P6 170W-857-W				
545001122400	LEDHighbay-P6 170W-857-N	1	LS017020015-02		
545001116300	LEDHighbay-P6 170W-DALI-857-N				
545001116400	LEDHighbay-P6 170W-DALI-857-W				
545001118700	LEDHighbay-P6 170W-BLE2-857-N				
545001118800	LEDHighbay-P6 170W-BLE2-857-W				
545001122800	LEDHighbay-P6 200W-840-AS	1	LS017020015-03		
545001119800	LEDHighbay-P6 200W-DALI-840-AS				
545001119200	LEDHighbay-P6 200W-BLE2-840-AS				
545001122600	LEDHighbay-P6 200W-840-W	1	LS017020018-02		
545001122700	LEDHighbay-P6 200W-840-N				
545001119600	LEDHighbay-P6 200W-DALI-840-N				
545001119700	LEDHighbay-P6 200W-DALI-840-W				
545001119000	LEDHighbay-P6 200W-BLE2-840-N				
545001119100	LEDHighbay-P6 200W-BLE2-840-W	1	LS017020018-03		
545001123100	LEDHighbay-P6 200W-857-AS				
545001119500	LEDHighbay-P6 200W-BLE2-857-AS				
545001120100	LEDHighbay-P6 200W-DALI-857-AS	1	LS017020018-03		
545001122900	LEDHighbay-P6 200W-857-W				
545001123000	LEDHighbay-P6 200W-857-N				
545001119300	LEDHighbay-P6 200W-BLE2-857-N				
545001119400	LEDHighbay-P6 200W-BLE2-857-W				
545001119900	LEDHighbay-P6 200W-DALI-857-N	1	LS017020018-03		
545001120000	LEDHighbay-P6 200W-DALI-857-W				

*Note: This product contains a light source of energy efficiency class (C).

LED Highbay Performer G6



Installation

Safety wire installation:

Pass the safety wire through the ceiling or fixed hook.
Fasten the two ends of the safety wire to both sides of the lamp body with screws.
Make sure the safety wire is tighten.



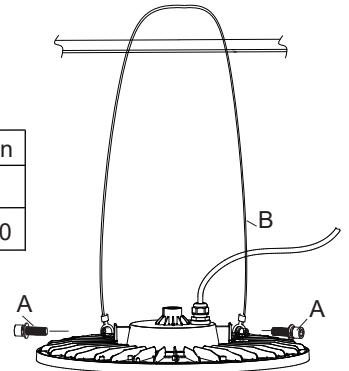

Warning: always take your responsibility to install the additional safety wire to ensure proper protection of your installation.

Picture	Code	Specification
	A	M8×20
	B	Φ2.0×L1200



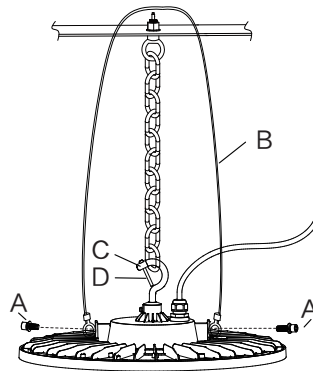
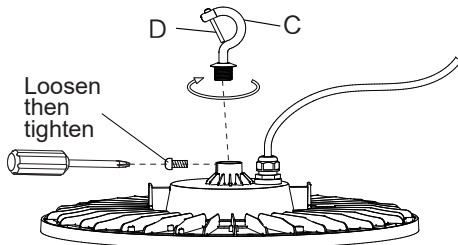

Hook

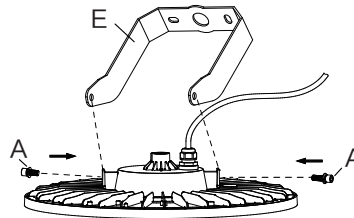
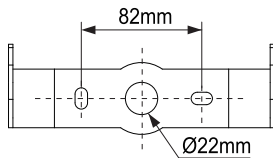

Picture	Code	Specification
	C	Rp1/2-14
	D	M6×40

Bracket (Available as accessory)







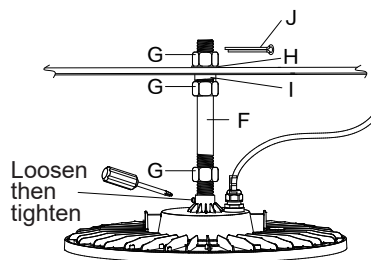
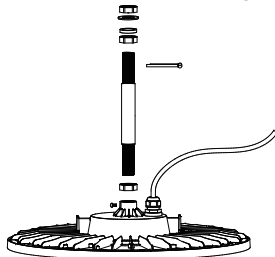

Picture	Code	Specification
	A	M8×20
	E	Bracket

Remark: Not included;
Please purchase separately.

*ACCESSORY NOT INCLUDED IN THE PACKAGING

Pole (Available as accessory)





Picture	Code	Specification
	F	Rp1/2-14-L300
	G	Rp1/2-14
	H	M20
	I	M20
	J	Φ3.0×L30

Remark: Not included;
Please purchase separately.

*ACCESSORY NOT INCLUDED IN THE PACKAGING

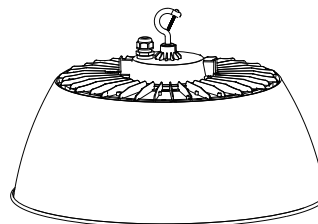
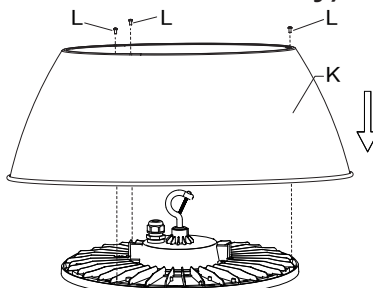
Reflector (Available as accessory)



Picture	Code	Specification
	K	Reflector
	L	M3×6

Remark: Not included;
Please purchase separately.

*ACCESSORY NOT INCLUDED IN THE PACKAGING

IP68 Connection (On/Off, BLE2)

Picture	Code	Specification
	M	Rubber Ring (thick) for Three-core Cable
	N	Rubber Ring (thin) for Five-core Cable

(Included in the packaging)

User's Connect Cable: Three-core Cable

min. Φ 7mm max. Φ 10mm
Cable: $3 \times 1.0 \sim 1.5 \text{mm}^2$

Note: No need to connect DALI+ cable and DALI- cable.

IP68 Connection (DALI)

Picture	Code	Specification
	M	Rubber Ring (thick) for Three-core Cable
	N	Rubber Ring (thin) for Five-core Cable

(Included in the packaging)

User's Connect Cable: Five-core Cable

min. Φ 10.5mm max. Φ 12mm
Cable: $5 \times 1.0 \sim 1.5 \text{mm}^2$

BLE2 Parameter

Bluetooth Operating frequency: 2400-2483.5 MHz
Bluetooth Max. Transmission Power $\leq 20 \text{ dBm (EIRP)}$

The product support various applications such as factory, mall, warehouse etc. Not for rough service.

Caution : Any operation is forbidden while power is on.

To reduce the risk of strangulation the flexible wiring connected to this luminaire shall be effectively fixed to the wall if the wiring is within arm's reach.



The external flexible cable or cord of this luminaire cannot be replaced; if the cord is damaged, the luminaire shall be destroyed.

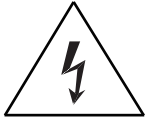

For non-user replaceable light sources.

The light source contained in this luminaire shall only be replaced by the manufacturer or his service agent or a similar qualified person.



For use in environments where normal non-conductive/conductive dust accumulation may be expected, not for use in environments with expected high/unusual dust accumulation.

