



Schijnwerper Floodlight Olympus G2

- Krachtige professionele schijnwerper voor sport- en terreinverlichting
- Alles-in-één LED-driver met flexibele montagemethoden en 220-400VAC stroomingang
- Standaard compatibel met DALI2 / 1-10V / DMX-dimmen
- Robuust ontwerp: volledige IP66- en IK08-bescherming, inclusief veiligheidskabel
- Voorzien van ontluchter om condensatie te voorkomen



Specificaties

Artikelcode	Artikelomschrijving	Equivalent (W)	Vermogen (W)	Lumen	Efficiëntie (lm/W)	CCT (K)	Bundelhoek	Nettogewicht (kg/st)
720001008900	LED FloodOly-P2 Re600-600W-757-W-LUM	HID 1000W	600	96000	160	5700	60°	15.23

Accessoires



709098001600
FloodOly-P Mounting-Kit-Out-Pole



709098001800
FloodOly-P Aiming-Device



709098003200
FloodOly-P Visor-Fixed-AS-Side-1Mod



709098003300
FloodOly-P Visor-Fixed-XN/N/W-1Mod

Artikel- en verpakkingsinformatie

Artikelcode	Item	EU HS-code	Afmetingen (mm) (LxBxH)	Doos		
				Brutogewicht (kg/st)	EAN	st/doos
720001008900	LED FloodOly-P2 Re600-600W-757-W-LUM	94051190	805x630x295	18.62	6941491785790	1
709098001600	FloodOly-P Mounting-Kit-Out-Pole	94059900	420x240x290	5.50	6931783016480	1
709098001800	FloodOly-P Aiming-Device	94051190	390x355x305	10.70	6931783016497	1
709098003200	FloodOly-P Visor-Fixed-AS-Side-1Mod	94059900	490x185x100	0.29	6931783026335	1
709098003300	FloodOly-P Visor-Fixed-XN/N/W-1Mod	94059900	490x145x110	0.35	6931783026342	1
720001010000	FloodOly-P2 Driver-600W-DA/10V/DMX	85369010	515x230x210	6.80	6941491785677	1

Technische specificaties

Levensduur (L70)	100.000 h
Levensduur (L80)	70.000 h
Aan-/Uit-cycli	100.000
Kleurconsistentie (SDCM)	6
Dimbaarheid	DALI2 / 1-10V / DMX
Afwerking	Mat zwart
Kleurweergave index (CRI)	> 70
Beschermingsgraad (IP)	IP66
Slagvastheid (IK)	IK08
Beschermingsklasse	I
Risicogroep (EN 62471)	RG1
Voorschakelapparaat inbegrepen	Nee
Gloeidraadtest	850 °C
Percentage uitval driver (na 5,000 uur)	≤ 0,003 %
Vermogensfactor	≥ 0,95
Piekspanning beveiliging (kV)	20 kV

Elektrische aansluiting

Frequentie	50 - 60 Hz
Nominale spanning	200 - 528 V
DC ingangsspanning	Zie catalogusbijlage Aansluitwaarden

Materiaal eigenschappen

Materiaal behuizing	Aluminium
Materiaal optiek	Polycarbonaat
Cover materiaal	Polycarbonaat
Kustlijnbestendig	Ja

Toepassingscondities

Bedrijfstemperatuur	-30 - 45 °C
Gebruikstemperatuur	25 °C
Opslagtemperatuur	-30 - 50 °C



Maatschets (mm)

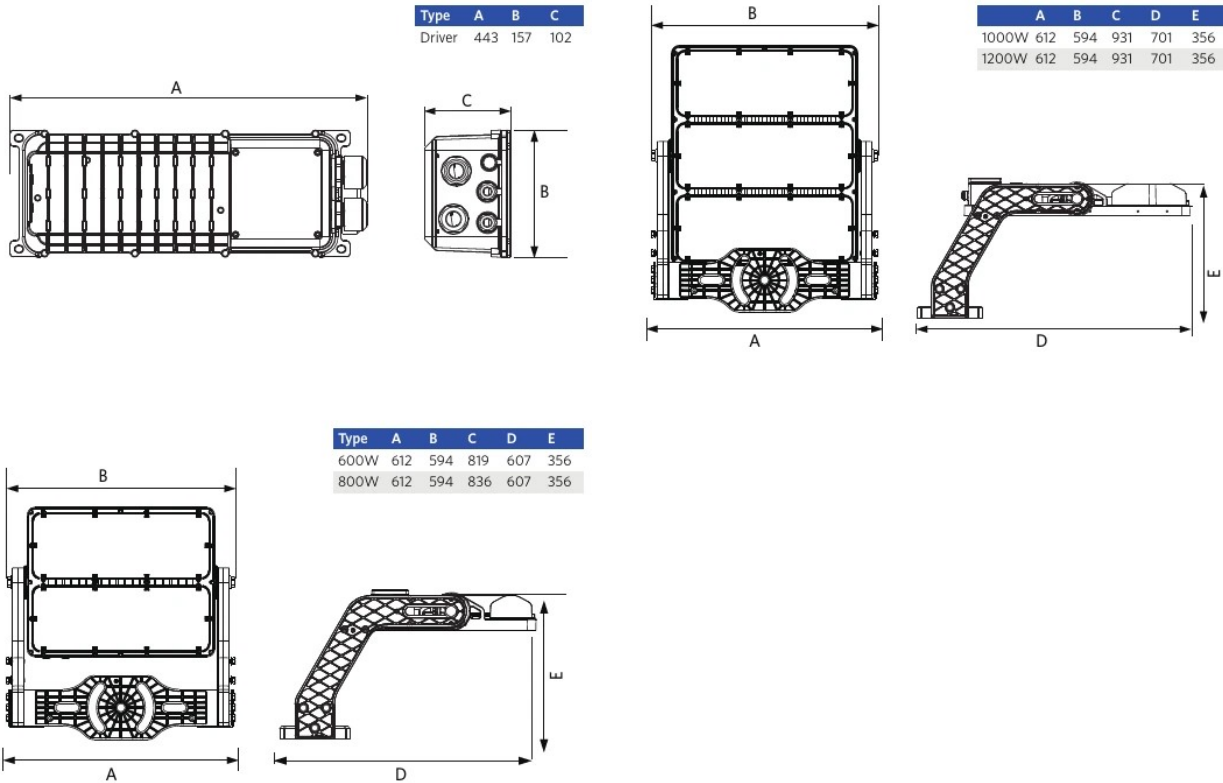

Fotometrische gegevens

