



Floodlight Olympus G2

- Powerful professional floodlighting solution for Sports and Area lighting
- All-in-one LED driver with flexible mounting methods and 220-400VAC power input
- Standard compatible with DALI2 / 1-10V / DMX dimming
- Robust design: full IP66 and IK08 protection, including safety cable
- Equipped with breather to prevent condensation



Specifications

Item Code	Item Description	Equivalent to (W)	Power (W)	Lumen	Efficacy (lm/W)	CCT (K)	Beam angle	Net Weight (pc/kg)
Luminaire (excluding driver)								
720001014700	LED FloodOly-P2 Re600-800W-740-XAS-LUM	HID 1000W	800	112000	140	4000	25° x 108°	15.23

Accessories



709098001600
FloodOly-P Mounting-Kit-Out-Pole



709098001800
FloodOly-P Aiming-Device



709098003200
FloodOly-P Visor-Fixed-AS-Side-1Mod



709098003300
FloodOly-P Visor-Fixed-XN/N/W-1Mod

Packaging information

Item		Box					
Item Code	Item Description	EU HS Code	Dimensions (mm) (LxWxH)	Gross Weight (pc/kg)	EAN	pc/box	
720001014700	LED FloodOly-P2 Re600-800W-740-XAS-LUM	94051190	805x630x295	18.62	6941491785905	1	
709098001600	FloodOly-P Mounting-Kit-Out-Pole	94059900	420x240x290	5.50	6931783016480	1	
709098001800	FloodOly-P Aiming-Device	94051190	390x355x305	10.70	6931783016497	1	
709098003200	FloodOly-P Visor-Fixed-AS-Side-1Mod	94059900	490x185x100	0.29	6931783026335	1	
709098003300	FloodOly-P Visor-Fixed-XN/N/W-1Mod	94059900	490x145x110	0.35	6931783026342	1	
720001014200	FloodOly-P2 Driver-800W-DA/10V/DMX-XAS	85369010	515x230x210	6.80	6941491785820	1	

Technical Specifications	
Lifetime (L70)	100,000 h
Lifetime (L80)	70,000 h
On-/Off-cycles	100,000
Colour consistency (SDCM)	6
Dimmability	DALI2 / 1-10V / DMX
Finishing	Matte Black
Colour rendering index (CRI)	> 70
Ingress Protection (IP)	IP66
Impact strength (IK)	IK08
Protection class	I
Risk group (EN 62471)	RG1
With control gear	False
Glow wire test	850 °C
Driver failure rate (at 5,000 hrs)	≤ 0.003 %
Power factor	≥ 0.95
Surge protection (kV)	20 kV

Electrical Supply	
Frequency	50 - 60 Hz
Nominal voltage	200 - 528 V
DC input voltage	See catalogue appendix Connection Specifications

Mechanical Properties	
Housing material	Aluminium
Optical material	Polycarbonate
Cover material	Polycarbonate
Coastal proof	Yes

Ambient Conditions	
Operating temperature	-30 - 45 °C
Application temperature	25 °C
Storage environment	-30 - 50 °C



Dimensional Drawing (mm)

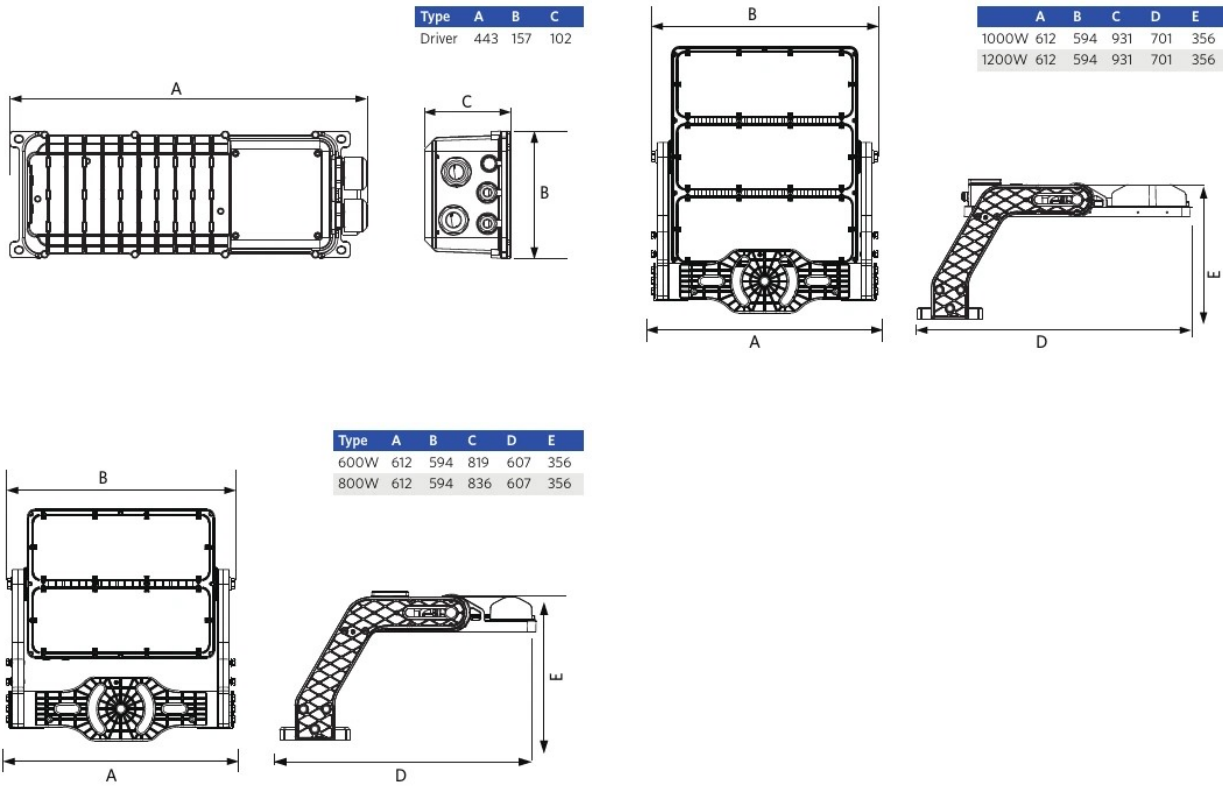

Photometric Data

