

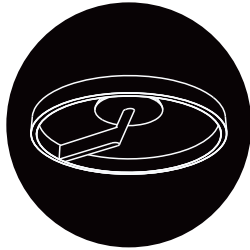

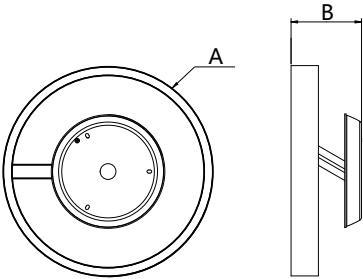

Item Code	Luminaire Description	CCT	kg	
521026006100	LEDRingo SDL-S Sf-Rd600-75W-BLE2-BL	1200K-18000K	4.8kg	
521026006200	LEDRingo SDL-S Sf-Rd400-53W-BLE2-BL	1200K-18000K	3.4kg	

	Model	A (mm)	B (mm)
	LEDRingo Sf-Rd600-75W-BLE2-BL	φ600	134
	LEDRingo Sf-Rd400-53W-BLE2-BL	φ400	134

Light Source

Product Code	Product Description	N	Light source code	QR Code	Energy Label
521026006100	LEDRingo SDL-S Sf-Rd600-75W-BLE2-BL	1	LS129007535-03		
521026006200	LEDRingo SDL-S Sf-Rd400-53W-BLE2-BL	1	LS129005335-03		

Installation

①

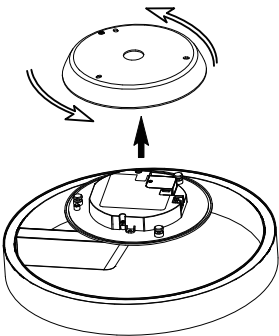

②

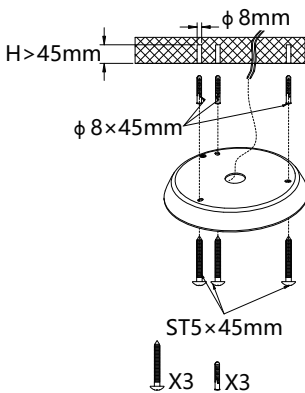

③

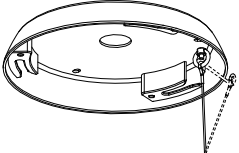

④

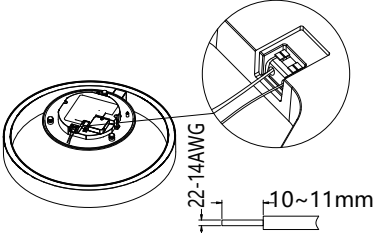

⑤

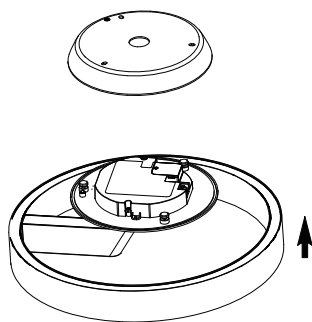

⑥

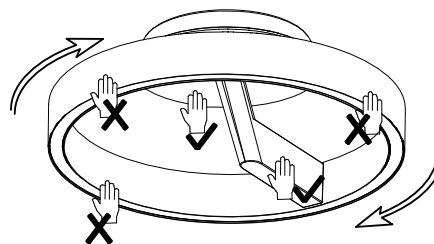

⑦

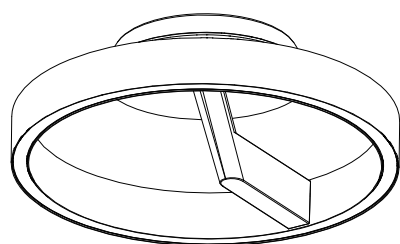

The light source in this luminaire is not user-replaceable. It must only be replaced by the manufacturer, an authorized service agent, or a similarly qualified professional.

Caution : Any operation is forbidden while power is on.

Indoor use only.

Ensure the luminaire is fully ceiling-mounted onto a solid, fire-resistant, and insulating surface. Avoid installing it on hollow or grid-like surfaces.

Ceiling luminaires, chandeliers, or other products exceeding 10 kg in weight must be installed on solid concrete ceilings. Use the provided screw accessory package for secure mounting.

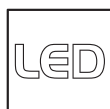

Data subject to change
Les données sont sujettes à modifications
Änderungen vorbehalten

OPPLE Lighting Co., Ltd.
Room 411, Building 1 No. 6111,
Longdong Avenue, Pudong New District,
Shanghai City 201201, P. R. China
www.opple.com

Opplé Lighting B.V.
Meerenakkerweg 1-07
5652 AR Eindhoven
The Netherlands
service@opple.com