

Suspended Halo

Item Code	Luminaire Description	CCT	kg
520036048000	LEDHalo-P Rd400-DALI-20W-830/840-D-U19	3000/4000K	3.30kg
520036048100	LEDHalo-P Rd600-DALI-40W-830/840-D-U19	3000/4000K	5.00kg
520036048200	LEDHalo-P Rd800-DALI-80W-830/840-D-U19	3000/4000K	8.50kg
520036048300	LEDHalo-P Rd400-BLE2-20W-830/840-D-U19	3000/4000K	3.30kg
520036048400	LEDHalo-P Rd600-BLE2-40W-830/840-D-U19	3000/4000K	5.00kg
520036048500	LEDHalo-P Rd800-BLE2-80W-830/840-D-U19	3000/4000K	8.50kg
520036048600	LEDHalo-P Rd400-DALI-20W-TW-D-U19	2700-6500K	3.30kg
520036048700	LEDHalo-P Rd600-DALI-40W-TW-D-U19	2700-6500K	5.00kg
520036048800	LEDHalo-P Rd800-DALI-80W-TW-D-U19	2700-6500K	8.50kg
520036048900	LEDHalo-P Rd400-BLE2-20W-TW-D-U19	2700-6500K	3.30kg
520036049000	LEDHalo-P Rd600-BLE2-40W-TW-D-U19	2700-6500K	5.00kg
520036049100	LEDHalo-P Rd800-BLE2-80W-TW-D-U19	2700-6500K	8.50kg
520036049200	LEDHalo-P Rd400-DALI-20W-830/840-D/I-U19	3000/4000K	4.00kg
520036049300	LEDHalo-P Rd600-DALI-40W-830/840-D/I-U19	3000/4000K	5.80kg
520036049400	LEDHalo-P Rd800-DALI-80W-830/840-D/I-U19	3000/4000K	9.50kg
520036049500	LEDHalo-P Rd400-BLE2-20W-830/840-D/I-U19	3000/4000K	4.00kg
520036049600	LEDHalo-P Rd600-BLE2-40W-830/840-D/I-U19	3000/4000K	5.80kg
520036049700	LEDHalo-P Rd800-BLE2-80W-830/840-D/I-U19	3000/4000K	9.50kg
520036049800	LEDHalo-P Rd400-DALI-20W-TW-D/I-U19	2700-6500K	4.00kg
520036049900	LEDHalo-P Rd600-DALI-40W-TW-D/I-U19	2700-6500K	5.80kg
520036050000	LEDHalo-P Rd800-DALI-80W-TW-D/I-U19	2700-6500K	9.50kg
520036050100	LEDHalo-P Rd400-BLE2-20W-TW-D/I-U19	2700-6500K	4.00kg
520036050200	LEDHalo-P Rd600-BLE2-40W-TW-D/I-U19	2700-6500K	5.80kg
520036050300	LEDHalo-P Rd800-BLE2-80W-TW-D/I-U19	2700-6500K	9.50kg
520098005100*	LEDHalo-P-Suspended-Kit-3 core-3000	/	0.20kg
520098005200*	LEDHalo-P-Suspended-Kit-5 core-3000	/	0.50kg
520098005300*	LEDHalo-P-Canopy	/	0.86kg
520098005400*	LEDHalo-P-Surface-Mounted-Kit-S	/	0.23kg
520098005500*	LEDHalo-P-Surface-Mounted-Kit-M	/	0.34kg
520098005600*	LEDHalo-P-Surface-Mounted-Kit-L	/	0.47kg

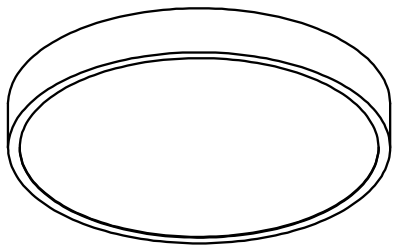

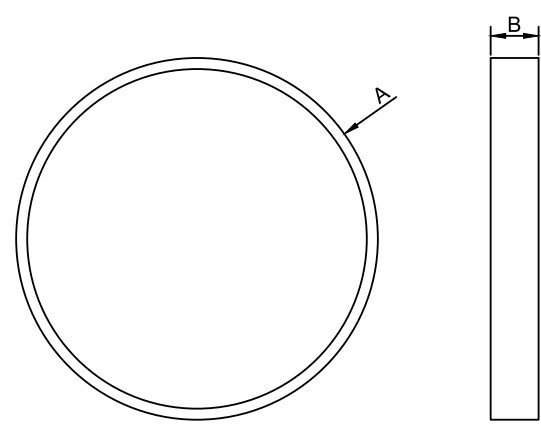























*Accessories should be purchased separately.



Model Name	A(mm)	B(mm)
LED SP-HALO-P RD400-20W-DALI-D-U19	φ400	80
LED SP-HALO-P RD600-40W-DALI-D-U19	φ600	80
LED SP-HALO-P RD800-80W-DALI-D-U19	φ800	80
LED SP-HALO-P RD400-20W-BLE-D-U19	φ400	80
LED SP-HALO-P RD600-40W-BLE-D-U19	φ600	80
LED SP-HALO-P RD800-80W-BLE-D-U19	φ800	80
LED SP-HALO-P RD400-20W-DALI-TW-D-U19	φ400	80
LED SP-HALO-P RD600-40W-DALI-TW-D-U19	φ600	80
LED SP-HALO-P RD800-80W-DALI-TW-D-U19	φ800	80
LED SP-HALO-P RD400-20W-BLE-TW-D-U19	φ400	80
LED SP-HALO-P RD600-40W-BLE-TW-D-U19	φ600	80
LED SP-HALO-P RD800-80W-BLE-TW-D-U19	φ800	80
LED SP-HALO-P RD400-20W-DALI-D/I-U19	φ400	80
LED SP-HALO-P RD600-40W-DALI-D/I-U19	φ600	80
LED SP-HALO-P RD800-80W-DALI-D/I-U19	φ800	80
LED SP-HALO-P RD400-20W-BLE-D/I-U19	φ400	80
LED SP-HALO-P RD600-40W-BLE-D/I-U19	φ600	80
LED SP-HALO-P RD800-80W-BLE-D/I-U19	φ800	80
LED SP-HALO-P RD400-20W-DALI-TW-D/I-U19	φ400	80
LED SP-HALO-P RD600-40W-DALI-TW-D/I-U19	φ600	80
LED SP-HALO-P RD800-80W-DALI-TW-D/I-U19	φ800	80
LED SP-HALO-P RD400-20W-BLE-TW-D/I-U19	φ400	80
LED SP-HALO-P RD600-40W-BLE-TW-D/I-U19	φ600	80
LED SP-HALO-P RD800-80W-BLE-TW-D/I-U19	φ800	80

Light Source

Model	N	Light source code	Position
LED SP-HALO-P RD400-20W-DALI-D-U19	1	LS140002032	Down
LED SP-HALO-P RD400-20W-BLE-D-U19	1	LS140002032	Down
LED SP-HALO-P RD600-40W-DALI-D-U19	1	LS140004032	Down
LED SP-HALO-P RD600-40W-BLE-D-U19	1	LS140004032	Down
LED SP-HALO-P RD800-80W-DALI-D-U19	1	LS140008032	Down
LED SP-HALO-P RD800-80W-BLE-D-U19	1	LS140008032	Down
LED SP-HALO-P RD400-20W-DALI-TW-D-U19	1	LS140002031	Down
LED SP-HALO-P RD400-20W-BLE-TW-D-U19	1	LS140002031	Down
LED SP-HALO-P RD600-40W-DALI-TW-D-U19	1	LS140004031	Down
LED SP-HALO-P RD600-40W-BLE-TW-D-U19	1	LS140004031	Down
LED SP-HALO-P RD800-80W-DALI-TW-D-U19	1	LS140008031	Down
LED SP-HALO-P RD800-80W-BLE-TW-D-U19	1	LS140008031	Down
LED SP-HALO-P RD400-20W-DALI-D/I-U19	1	LS140000432	UP
	1	LS140002032	Down
LED SP-HALO-P RD400-20W-BLE-D/I-U19	1	LS140000432	UP
	1	LS140002032	Down
LED SP-HALO-P RD600-40W-DALI-D/I-U19	1	LS140000832	UP
	1	LS140004032	Down
LED SP-HALO-P RD600-40W-BLE-D/I-U19	1	LS140000832	UP
	1	LS140004032	Down
LED SP-HALO-P RD800-80W-DALI-D/I-U19	1	LS140001632	UP
	1	LS140008032	Down
LED SP-HALO-P RD800-80W-BLE-D/I-U19	1	LS140001632	UP
	1	LS140008032	Down
LED SP-HALO-P RD400-20W-DALI-TW-D/I-U19	1	LS140000431	UP
	1	LS140002031	Down
LED SP-HALO-P RD400-20W-BLE-TW-D/I-U19	1	LS140000431	UP
	1	LS140002031	Down
LED SP-HALO-P RD600-40W-DALI-TW-D/I-U19	1	LS140000831	UP
	1	LS140004031	Down
LED SP-HALO-P RD600-40W-BLE-TW-D/I-U19	1	LS140000831	UP
	1	LS140004031	Down
LED SP-HALO-P RD800-80W-DALI-TW-D/I-U19	1	LS140001631	UP
	1	LS140008031	Down
LED SP-HALO-P RD800-80W-BLE-TW-D/I-U19	1	LS140001631	UP
	1	LS140008031	Down

Light source code	QR Code	Energy Label
LS140002032		
LS140000432		
LS140004032		
LS140000832		
LS140008032		
LS140001632		
LS140002031		
LS140000431		
LS140004031		
LS140000831		
LS140008031		
LS140001631		

Packaging Includes

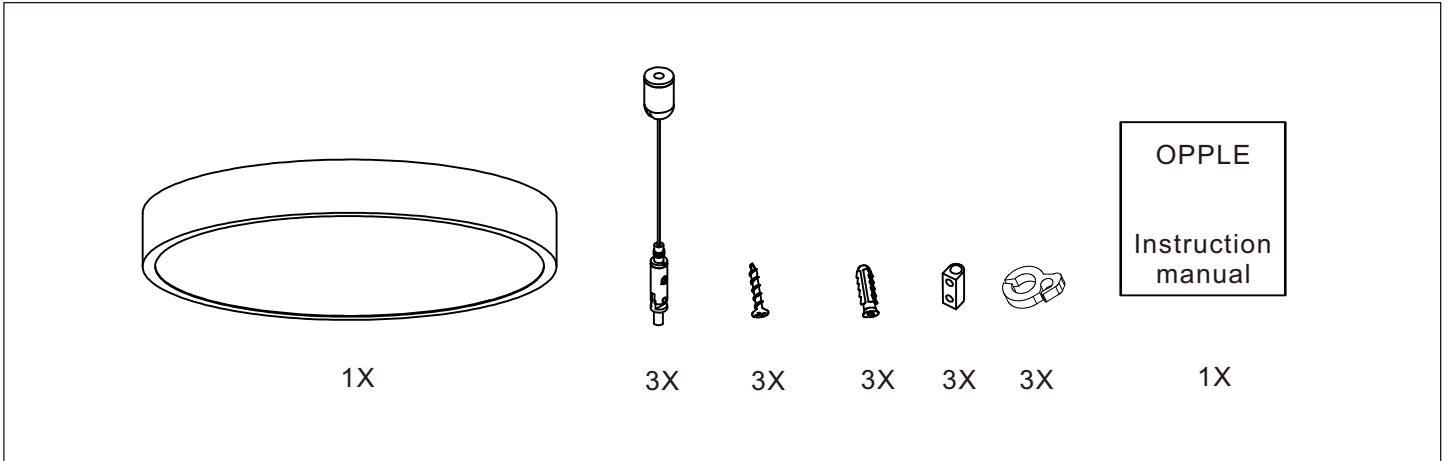

CCT Dip switch

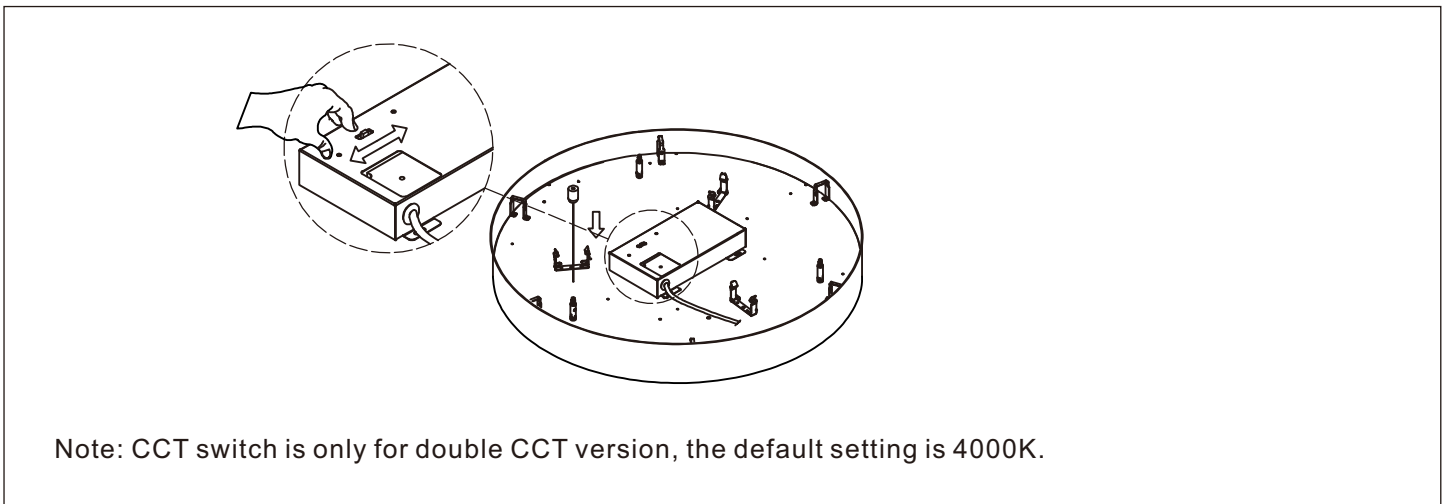

Wiring Connection

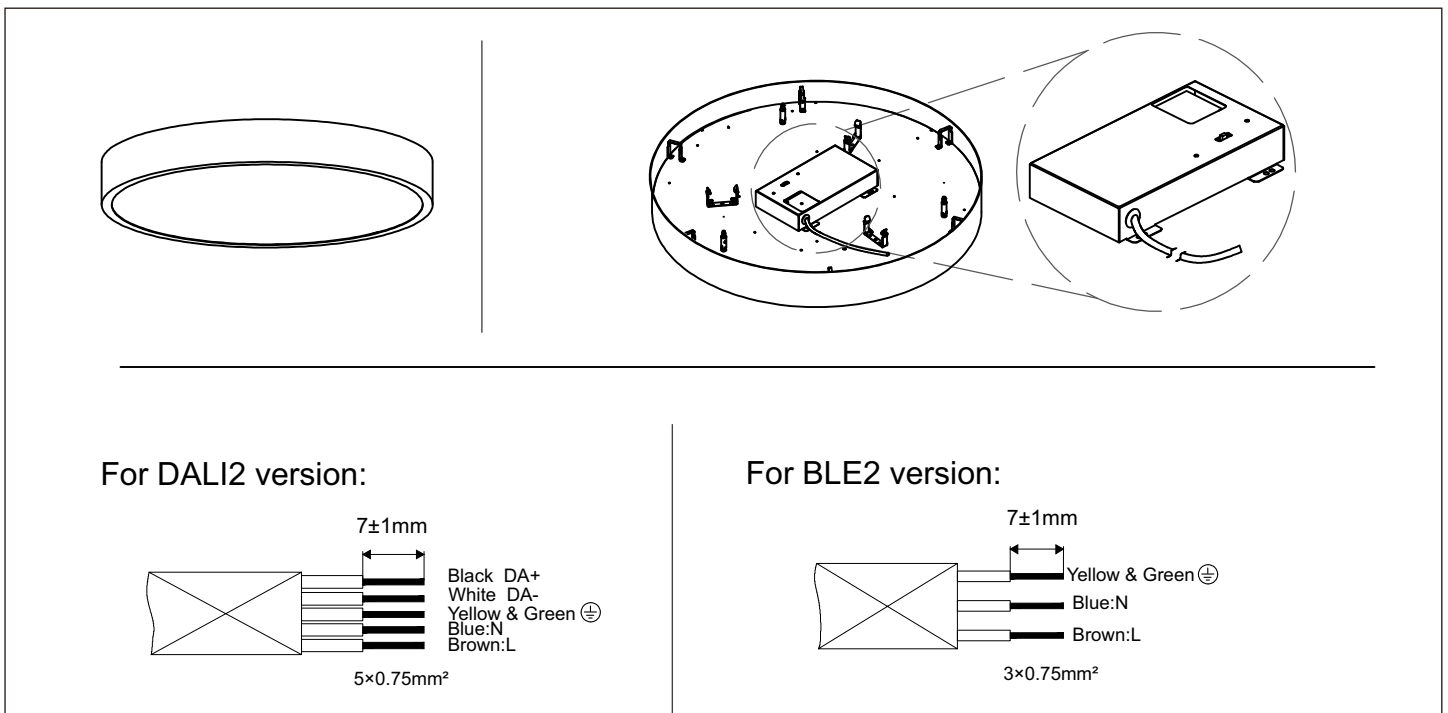

Suspended Mounting

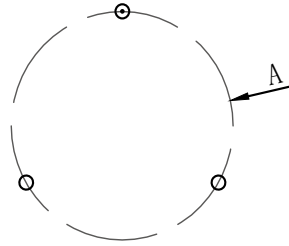
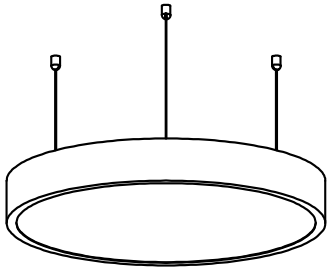

Model Name	A (mm)
LEDHalo-P Rd400	180
LEDHalo-P Rd600	240
LEDHalo-P Rd800	320

①

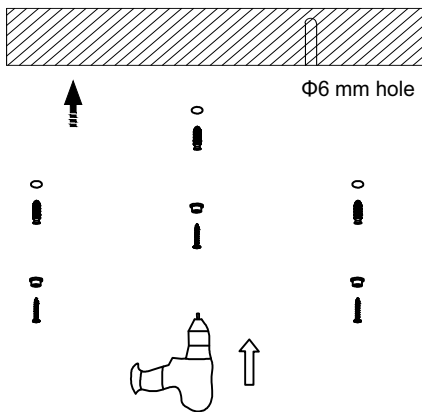

②

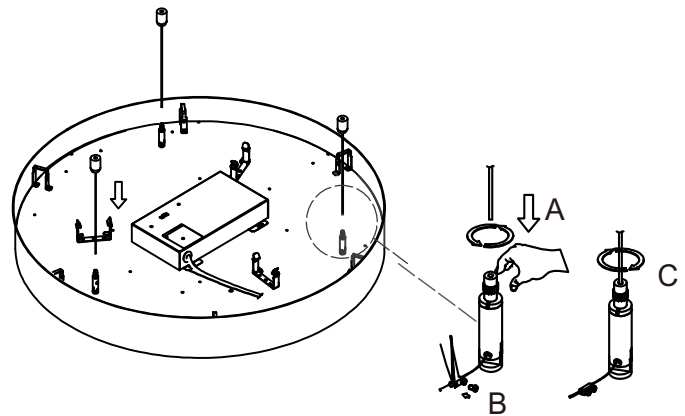

Max. suspension length of wire is 1.5m.

③

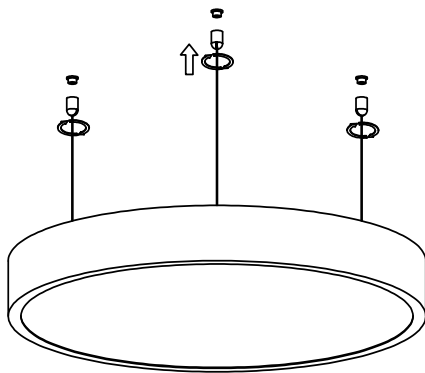

④

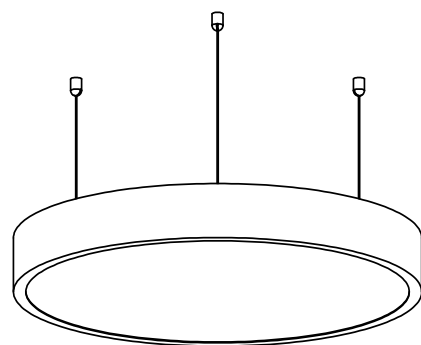

Suspended Mounting with Canopy

Item code	Luminaire Description
520098005300*	LEDHalo-P-Canopy

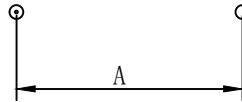
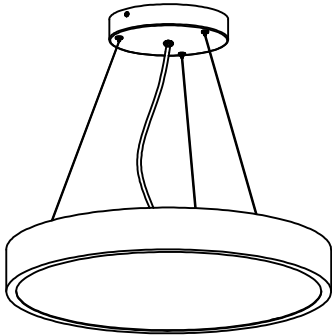
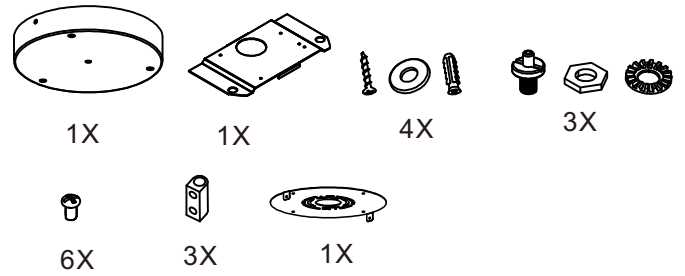

Model Name	A (mm)
LEDHalo-P Rd400	180
LEDHalo-P Rd600	180
LEDHalo-P Rd800	180

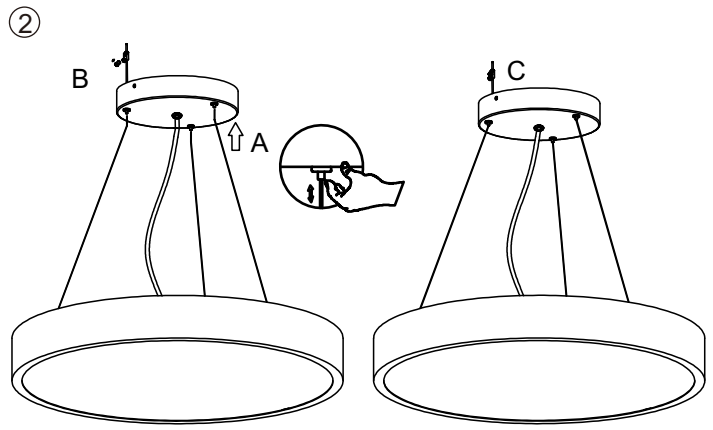
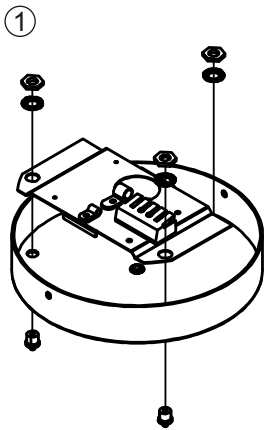

Max. suspension length of wire is 1.5m.

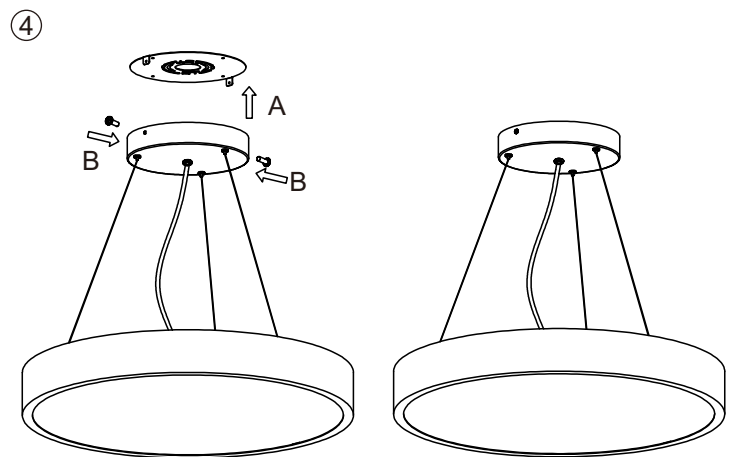
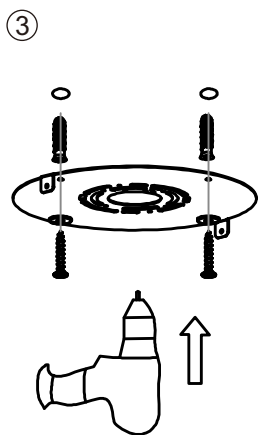

Surface mounted

Item code	Luminaire Description
520098005400*	LEDHalo-P-Surface-Mounted-Kit-S
520098005500*	LEDHalo-P-Surface-Mounted-Kit-M
520098005600*	LEDHalo-P-Surface-Mounted-Kit-L

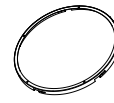

1x



2x



For Ø400/Ø600: 5x
For Ø800: 8x

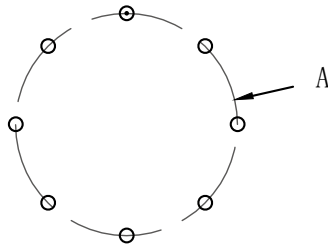
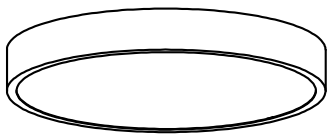

Model Name	A (mm)
LEDHalo-P Rd400	372
LEDHalo-P Rd600	572
LEDHalo-P Rd800	772

①

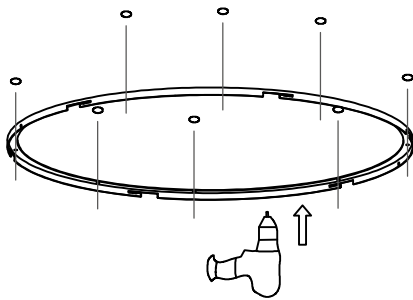

②

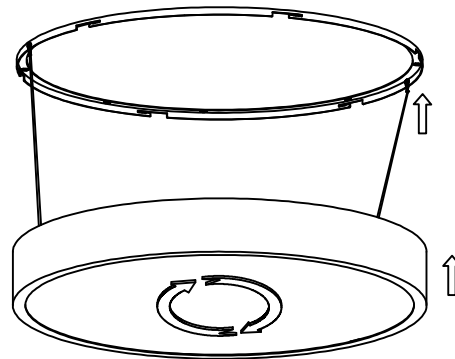

③

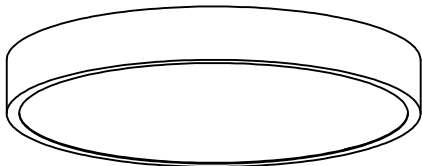

Dali version (Touch Dim Function)

Wrong connection

Good connection

Function	Contact Duration	Reaction
Ignore	<50ms	Nothing
Short Push	50-500ms	Turn on or off
Long Push	>500ms	Dimming up or down
Synchronisation	10s	Go to SYNC level, 50%
	20s	Go to SYNC level, 100%

Touch Dim Terminal Consumption: Typical 3mA(220V).

Warning: The Touch Dim function and DALI function cannot be used at the same time. This may damage the DALI system due to high voltage.

Caution

The luminaire is only suitable for 220–240 V AC supply.
 The controlgear for the connection panel should be SELV.
 It must be basic insulation between FELV and SELV, as is FELV and LV supply for 1-10V and DALI type.
 The light source contained in this luminaire shall only be replaced by the manufacturer or his service agent or a similar qualified person.

Caution: Any operation on the LED module is strictly forbidden while the power is on.
 Defective wiring must only be replaced by the manufacturer, distributor, or a qualified technician.
 Achtung: Arbeiten am LED-Modul sind während des Betriebs strikt verboten.
 Defekte Leitungen dürfen ausschließlich vom Hersteller, Händler oder einer qualifizierten Fachkraft ausgetauscht werden.

For type Y attachments:
 If the external flexible cable or cord of this luminaire is damaged, it shall be exclusively replaced by the manufacturer or his service agent or a similar qualified person in order to avoid a hazard.

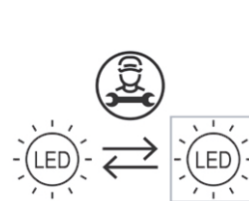
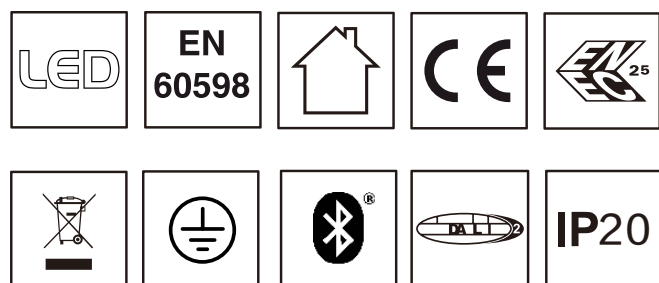

Data subject to change
 Les données sont sujettes à modifications.
 Änderungen vorbehalten

OPPLE Lighting Co., Ltd.
 Room 411, Building 1 No. 6111,
 Longdong Avenue, Pudong New District,
 Shanghai City 201201, P. R. China
www.opple.com

Oppl Lighting B.V.
 Meerenakkerweg 1-07
 5652 AR Eindhoven
 The Netherlands
service@opple.com