

Downlight Performer G2 MW

- Hoogwaardige LED Downlight met verbeterde efficiëntie tot 130 lm/W met CRI90 voor alle versies
- Geïntegreerde CCT schakelaar voor kleurkeuze (3000K-4000K)
- Uniek optisch lensconcept met matwitte (MW) reflector en lage verblinding
- Directe vervanging voor compacte fluorescentie downlights
- IP54 aan lichtuitvoerkant
- Voorzien van beschermingsfolie ter voorkoming van stof en vuil in het armatuur gedurende de montage



Specificaties

Artikelcode	Artikelomschrijving	Equivalent (W)	Vermogen (W)	Lumen	Efficiëntie (lm/W)	UGR	CCT (K)	Nettogewicht (kg/st)
Wieland GST18I2 aansluitsnoer (2x0.75mm² 0.3m)/Aan-Uit								
540001384700	LEDDL-MW-P2 Rd200-22W-930/940-WL	CFL 2x26W	22	2860	130	22	3K/4K	0.83

Verkrijgbaar op aanvraag met Wieland GST18- (-WL) of WAGO WINSTA-connector of Euro-/Schuko-stekker. DALI2 uitvoering compatibel met centrale noodverlichting volgens de norm EN 50172.

Accessoires



140060647
LEDDownlightRc-P-SI-E-
Adapter-200-225



140060648
LEDDownlightRc-P-SI-E-
Adapter-200-250



542098000800
LEDPanelRC-SI U19 EM-kit
1h



542098000900
LEDPanelRC-SI U19 EM-kit
3h



542098030700
Junction-Box-WH

Artikel- en verpakkingsinformatie

Item			Doos			
Artikelcode	Artikelomschrijving	EU HS-code	Afmetingen (mm) (LxBxH)	Brutogewicht (kg/st)	EAN	st/doos
540001384700	LEDDL-MW-P2 Rd200-22W-930/940-WL	94051190	229x246x75	0.92	6941491747378	1
140060647	LEDDownlightRc-P-SI-E-Adapter-200-225	94059900	255x255x20	0.23	6956321894139	1
140060648	LEDDownlightRc-P-SI-E-Adapter-200-250	94059900	280x280x20	0.20	6956321894146	1
542098000800	LEDPanelRC-SI U19 EM-kit 1h	85044083	490x390x150	0.98	6941497702340	1
542098000900	LEDPanelRC-SI U19 EM-kit 3h	85044083	490x390x150	1.08	6941497702333	1
542098030700	Junction-Box-WH	85369010	44x104x36	0.06	6941408868684	1
540098018400	LEDDownlight-P-Surface-Module-Rd200	94051190	280x280x241	2.00	6941491749556	1

Technische specificaties

Levensduur (L70)	100.000 h
Levensduur (L80)	70.000 h
Aan-/Uit-cycli	100.000
Kleurconsistentie (SDCM)	4
Dimbaarheid	On-Off
Bundelhoek	70 °
Afwerking	Wit RAL9003
RAL-Nummer	9003
Kleurweergave index (CRI)	> 90
Beschermingsgraad voorzijde (IP)	IP54
Beschermingsgraad achterzijde (IP)	IP20
Slagvastheid (IK)	IK02
Beschermingsklasse	II
Risicogroep (EN 62471)	RG0 / RG1 (22W & 30W & 40W)
Voorschakelapparaat inbegrepen	Ja
Gloeidraadtest	650 °C
Percentage uitval driver (na 5,000 uur)	≤ 1 %
Vermogensfactor	≥ 0,9

Elektrische aansluiting

Frequentie	50 - 60 Hz
Nominale spanning	220 - 240 V
DC ingangsspanning	Zie catalogusbijlage
	Aansluitwaarden

Materiaal eigenschappen

Materiaal behuizing	Aluminium
Materiaal optiek	Polycarbonaat

Toepassingscondities

Bedrijfstemperatuur	-10 - 45 °C
Gebruikstemperatuur	25 °C
Opslagtemperatuur	-25 - 50 °C

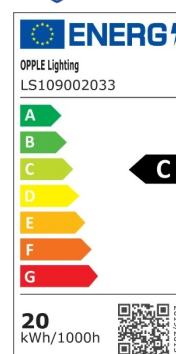

Maatschets (mm)

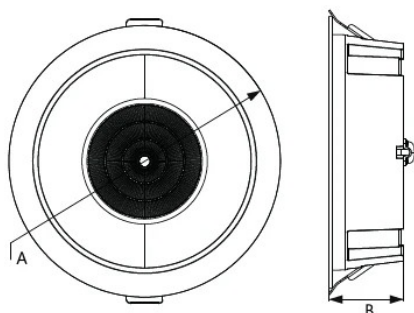

	A	B
Rd125	138	44
Rd150	173	51
Rd200	226	62



	A	B	C
On/Off	160	56	24
Dim	180	51	31

Tekening inbouwmaat (mm)

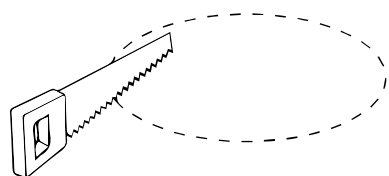

Ø125

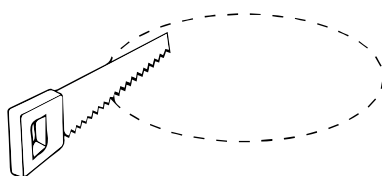

Ø150

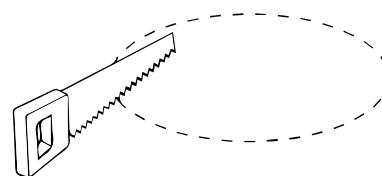

Ø200

Fotometrische gegevens

