

LED Linear Sport Light

Item Code

Luminaire Description

CCT

kg

545007006400	LEDLinear-Sport-P L15-90W-D4i-840	4000K	4.0kg
545007006900	LEDLinear-Sport-P L15-180W-D4i-840	4000K	6.1kg
545007006700*	LEDLinear-Sport-P Suspension-Kit		0.12kg
545007005900*	LEDLinear-Sport-P Rotate-Bracket		0.65kg
545007006500*	LEDLinear-Sport-P Recessed-Kit		0.13kg
545007006300*	LEDLinear-Sport-P BLE2-Converter		0.64kg

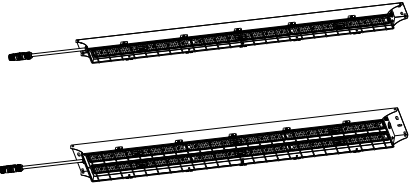

* Accessories should be purchased separately.

90W-D4i

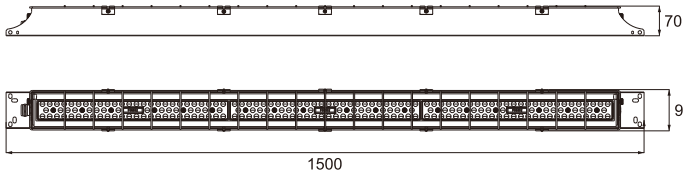

180W-D4i

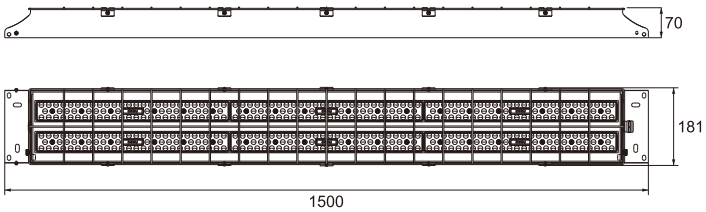

Model Name	L (mm)	W (mm)	H (mm)	Rated Voltage(V~)	Frequency (Hz)	Power Factor	Curent (A)	Rated Power(W)
LEDLinear-Sport-P L15-90W-D4i-840	1500	97	70	220-240	50/60	0.9	0.45	90
LEDLinear-Sport-P L15-180W-D4i-840	1500	181	70	220-240	50/60		0.91	180

Product Code	Product Description	N	QR Code	Energy Label
545007006400	LEDLinear-Sport-P L15-90W-D4i-840	1		
545007006900	LEDLinear-Sport-P L15-180W-D4i-840	2		
545007006600	LEDLinear-Sport-P L15-90W-BLE2-840	1		
545007006800	LEDLinear-Sport-P L15-180W-BLE2-840	2		

Installation

Ceiling Mounting

1. ✂

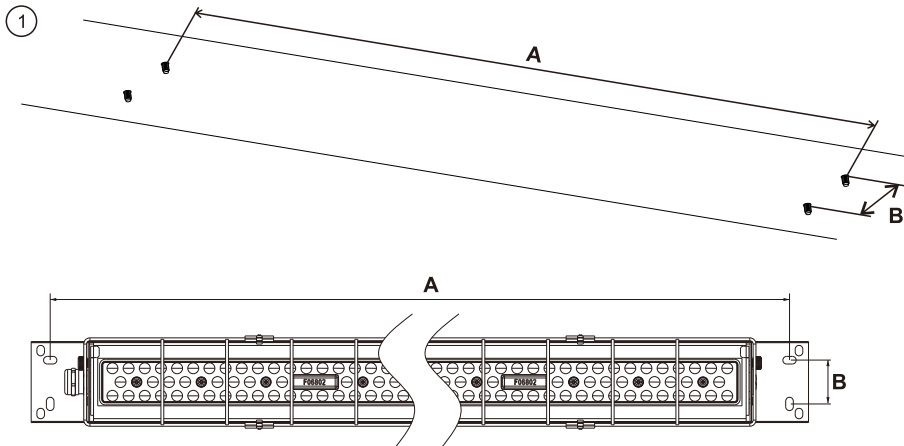

	A	B
90W	1456mm	49mm
180W	1456mm	49mm

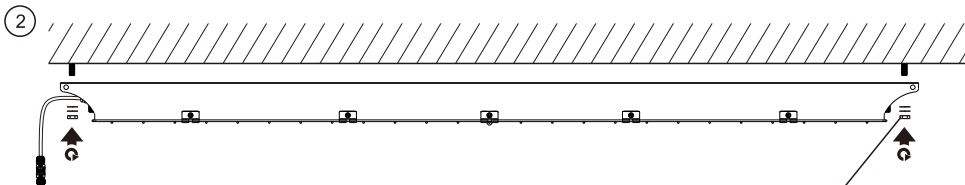

Recommended screw size:
 90W: M8
 180W: M8

90W/180W

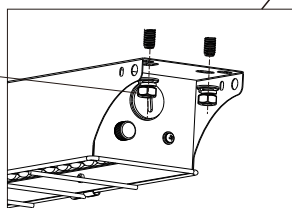
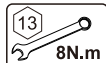

2. ✂

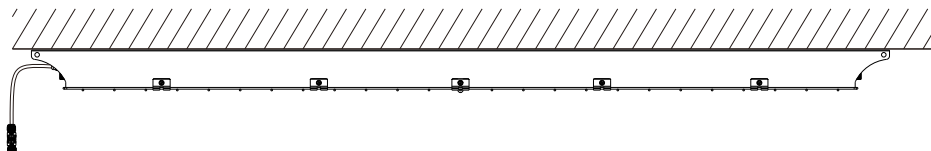

Rotate Bracket Mounting

1. ✂

90W

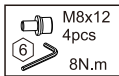
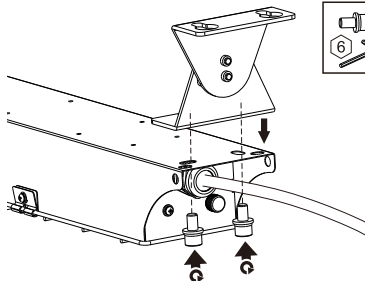

180W

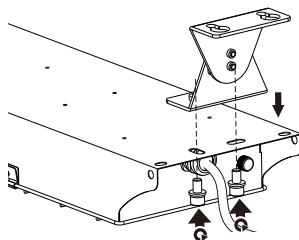

2. ✂

①

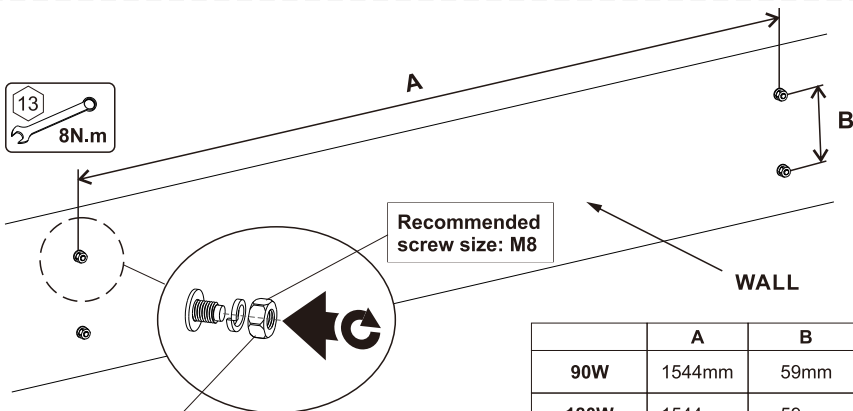
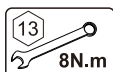

* Do not tighten the screws

	A	B
90W	1544mm	59mm
180W	1544mm	59mm

②

90W

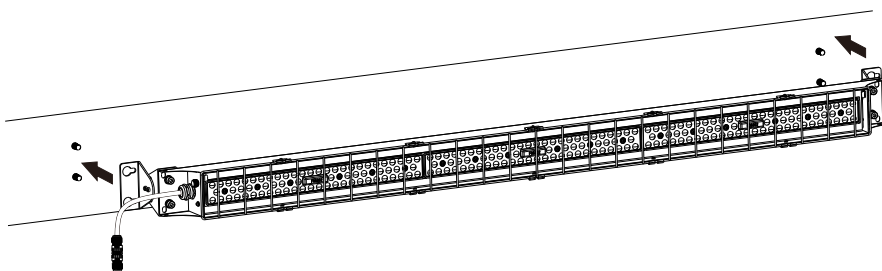

180W

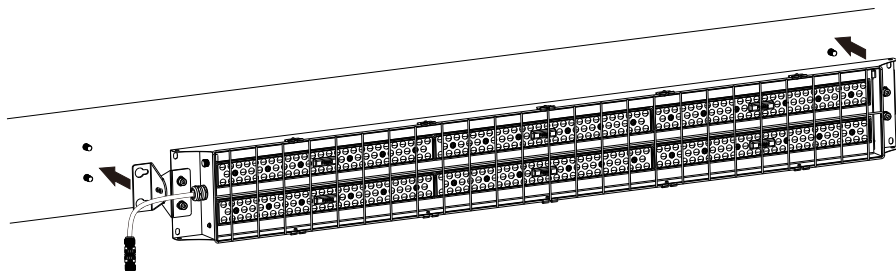

3

90W

Tighten the screws

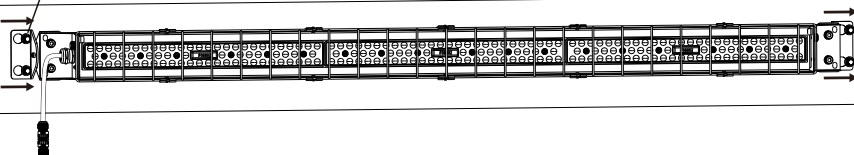
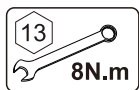
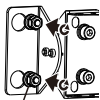

180W

Tighten the screws

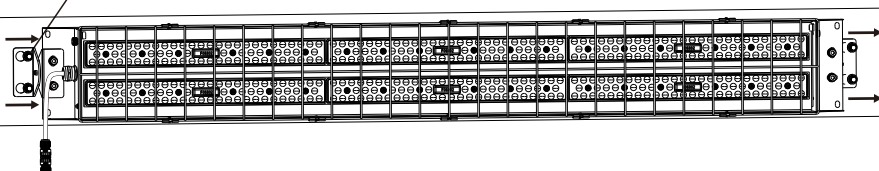
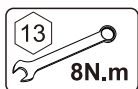
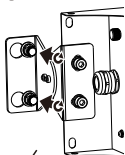

Angle of rotation

90W

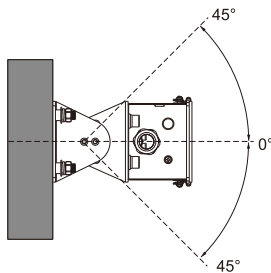
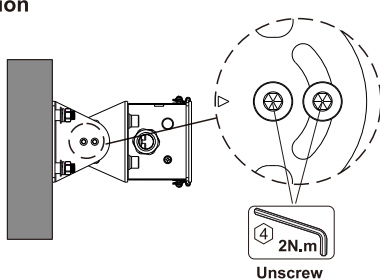

180W

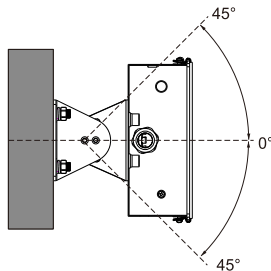
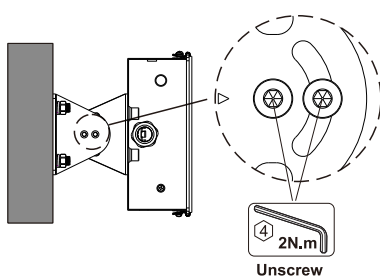

Recessed Mounting

1. ✂

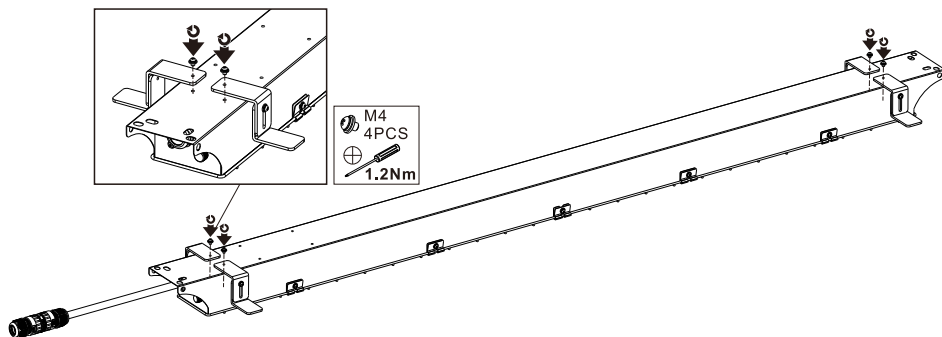

2. ✂

Cut-out Dimension

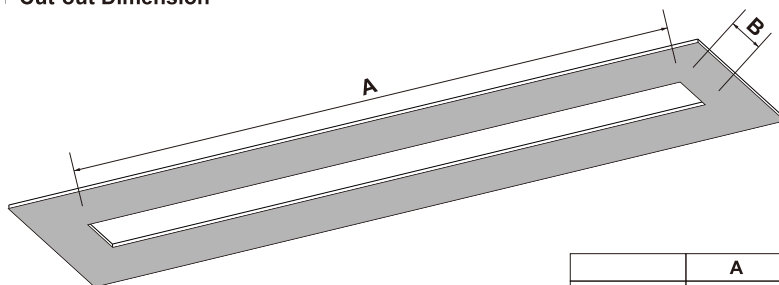

	A	B
90W	1441mm	69mm
180W	1441mm	106mm

3. ✂

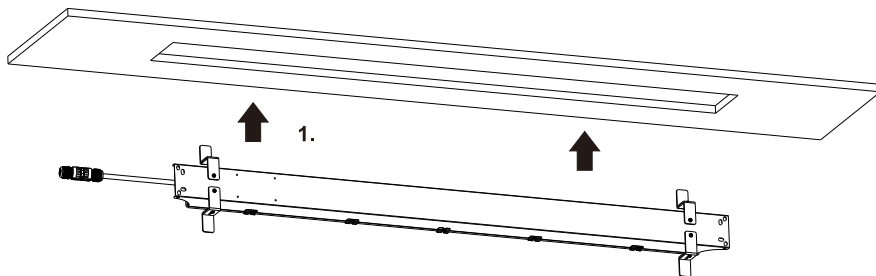

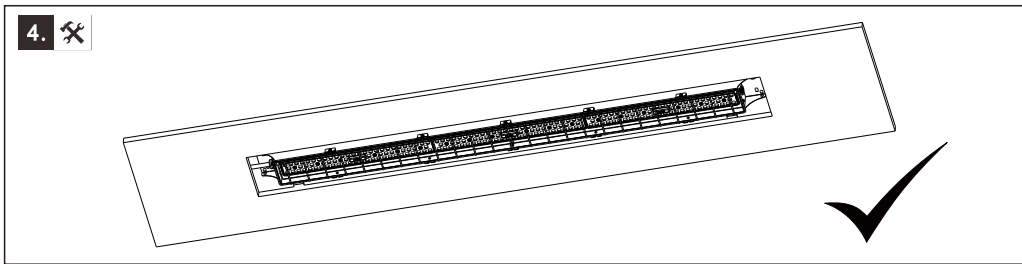

Suspension Mounting

1. ✖

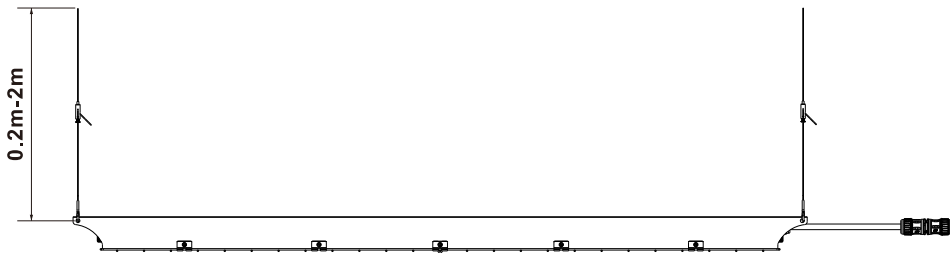
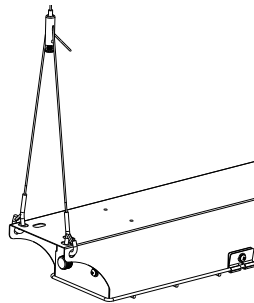
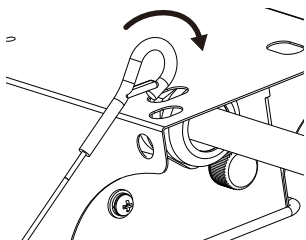

2. ✖

90W

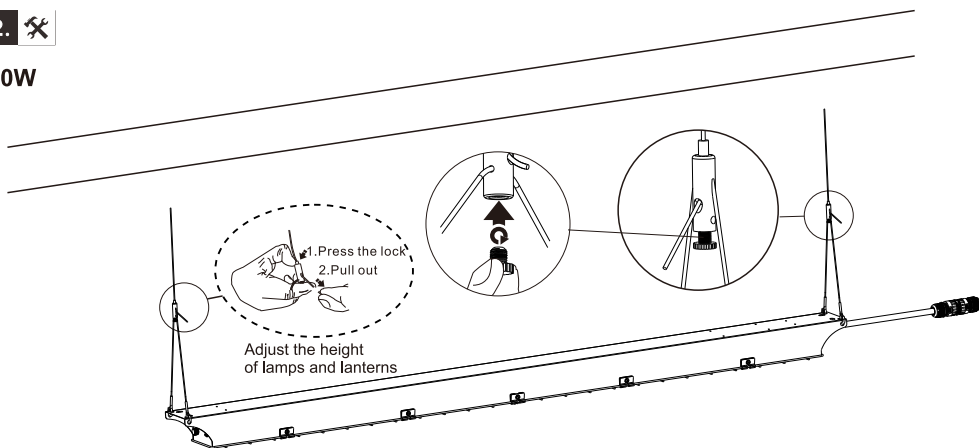

180W

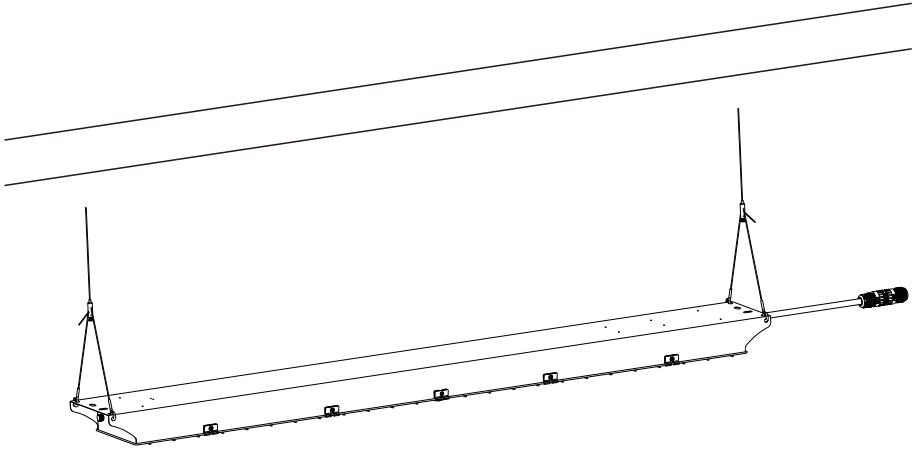

BLE2-Converter Mounting

1. 

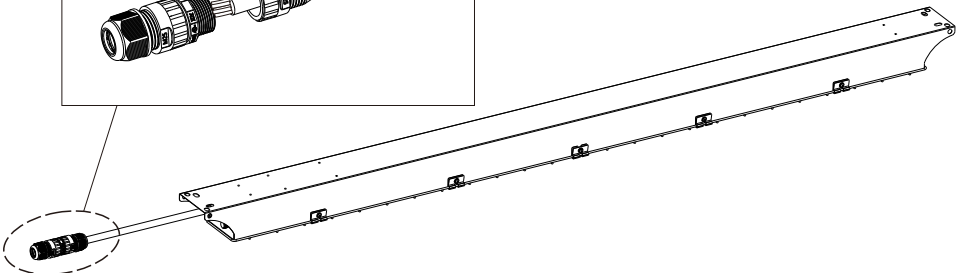
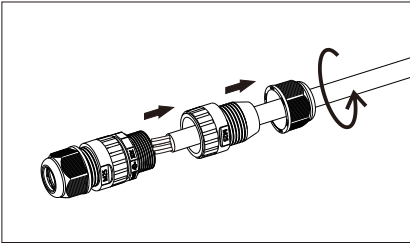

2. 

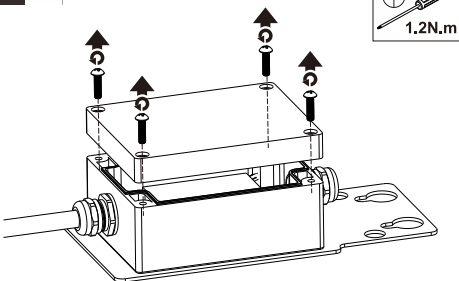

3. 

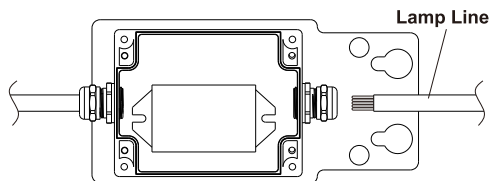

4. 

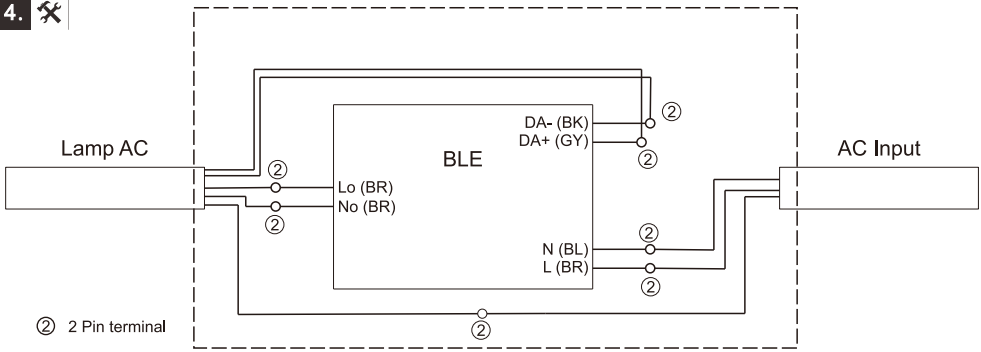

5. 

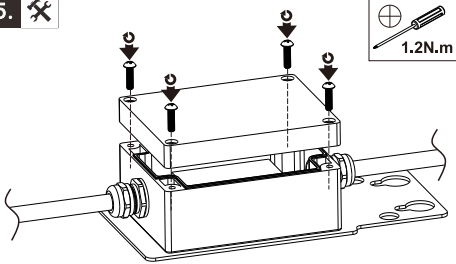

6. 

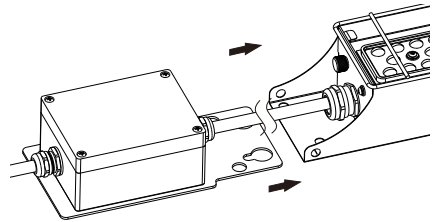

7. 

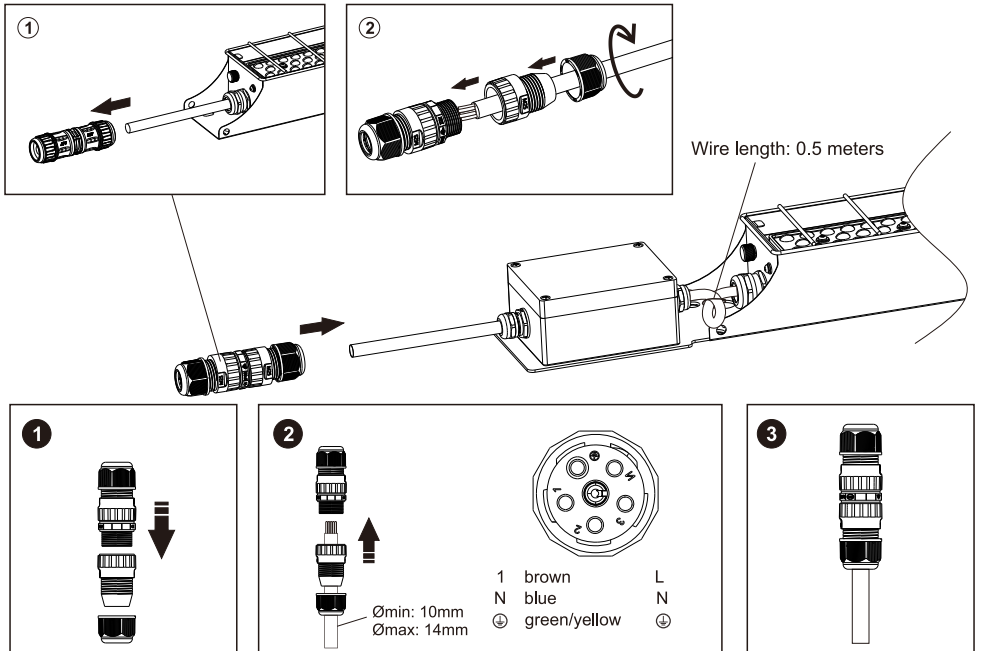

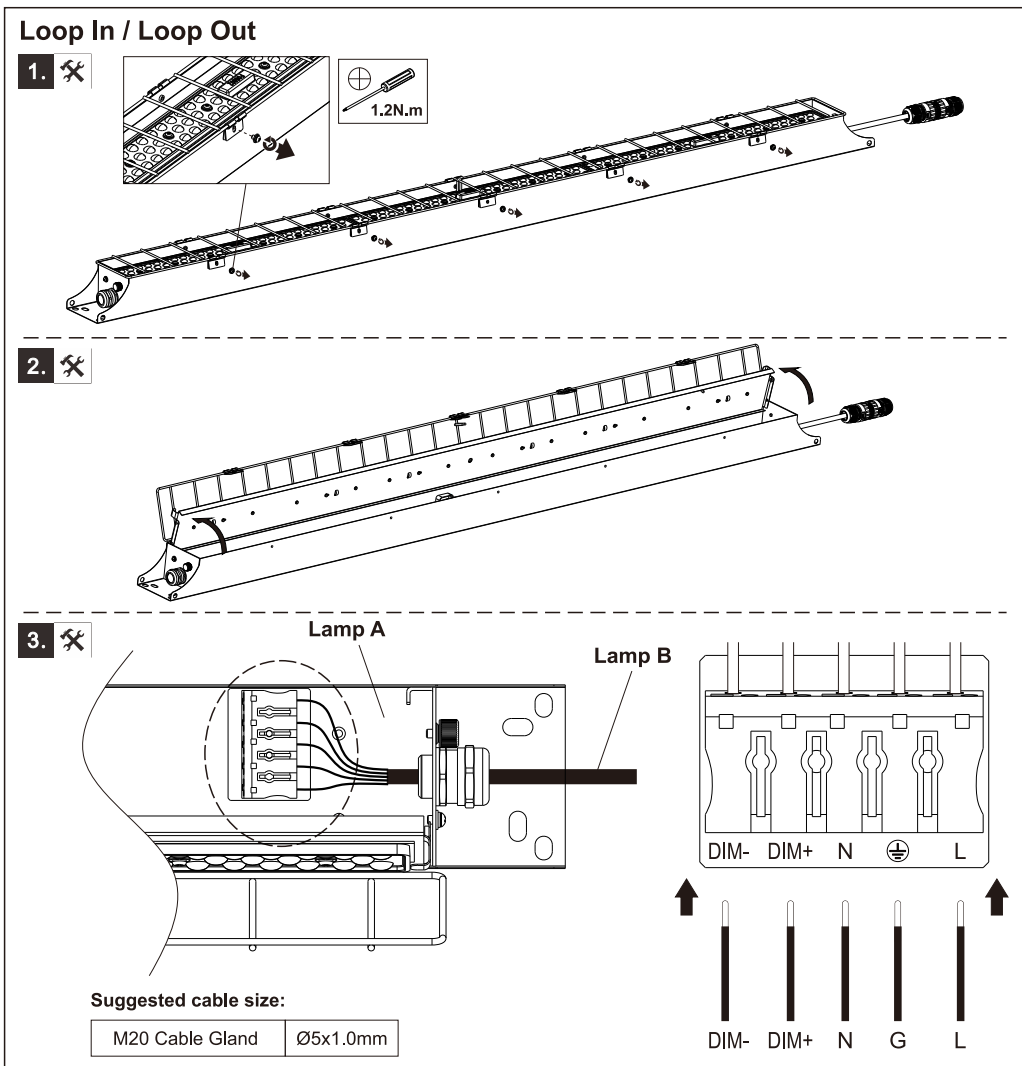
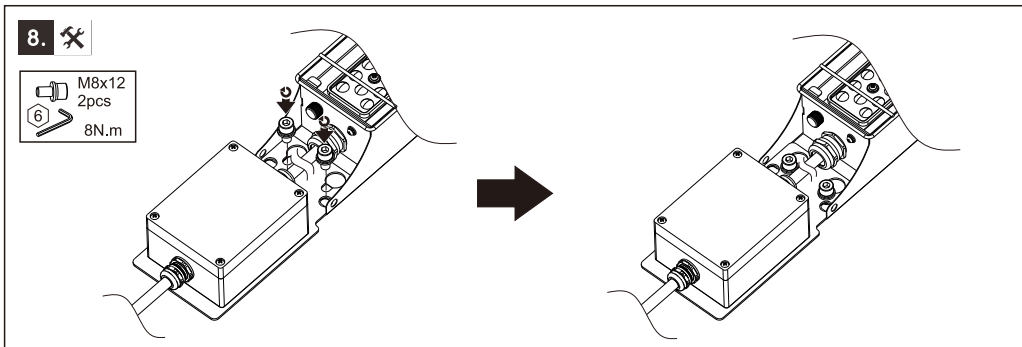

4. ⚡

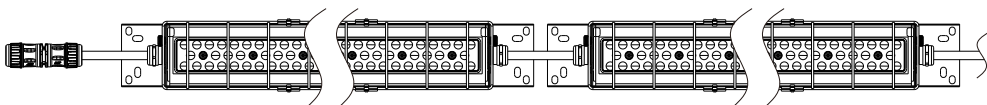

For 90W, Max. Allowed Products: 12 pcs
For 180W, Max. Allowed Products: 6 pcs

Wiring

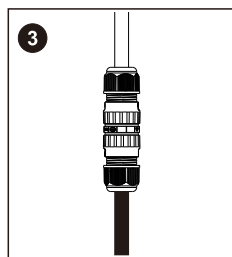
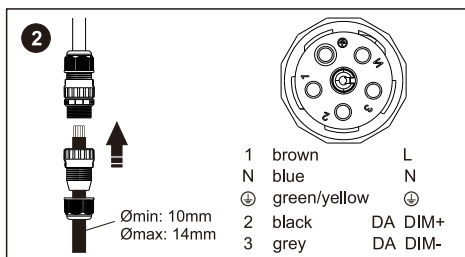
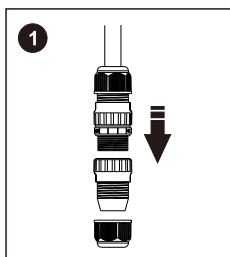
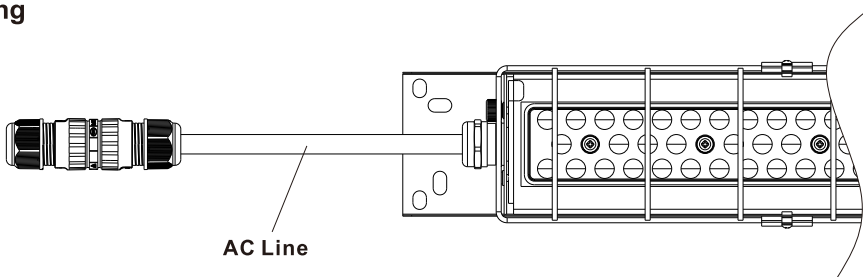

Caution: Any operation on LED module is forbidden while power-on. Zur Vermeidung von Risiken müssen defekte Leitungen ausschließlich vom Hersteller, nverkehrbringer oder Fachmann ausgetauscht werden. Achtung: In Betrieb ist keine Arbeit am LED-Modul erlaubt.



For non-user replaceable light sources :

The light source contained in this luminaire shall only be replaced by the manufacturer or his service agent or a similar qualified person. Das Leuchtmittel dieser Leuchte is nicht austauschbar. Wenn das Leuchtmittel das Ende seiner Lebensdauer erreicht hat, muss die gesamte Leuchte ersetzt werden.

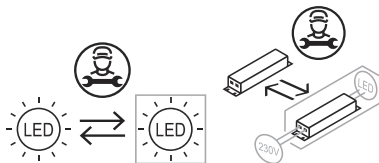

Data subject to change
Les données sont sujettes à modifications
Änderungen vorbehalten

OPPLE Lighting Co., Ltd.
Room 411, Building 1 No. 6111,
Longdong Avenue, Pudong New District,
Shanghai City 201201, P. R. China
www.opple.com

Opplle Lighting B.V.
Meerenakkerweg 1-07
5652 AR Eindhoven
The Netherlands
service@opple.com
www.opple.com