

INSTRUCTION MANUAL

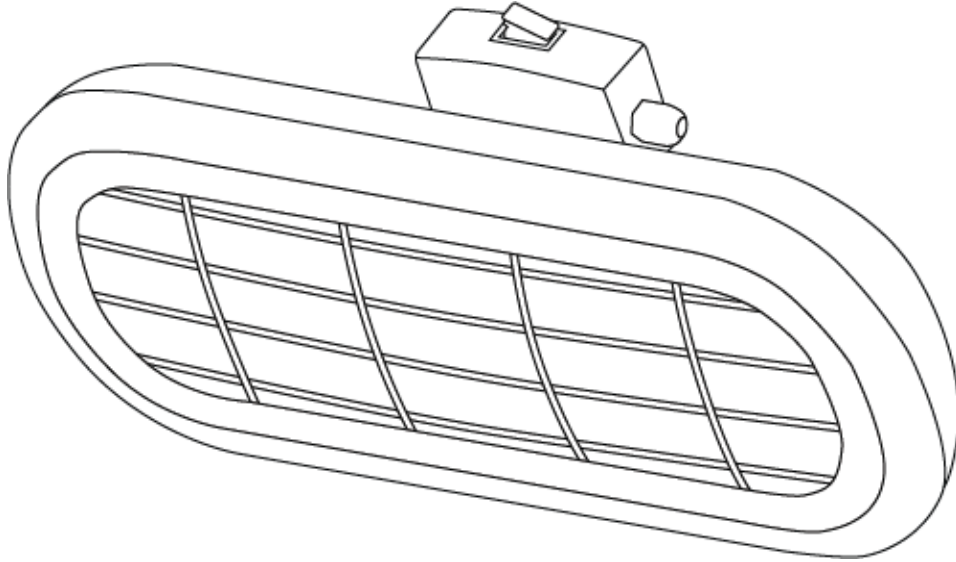

(This image is for reference only; it does not mean you are purchasing an identical product.
Heater picture is for illustration purposes only. Styles may vary according to the model.)

Model:- SUNB2000BL



CAUTION

Read Instructions Carefully
For Safe Installation and
Heater Operation

CONTENTS

- MAIN TECHNICAL DATA
- INSTALLATION CAUTION
- WALL/CEILING INSTALLATION
- MAINTENANCE
- STORAGE AND DISPOSAL

THANK YOU FOR PURCHASING

Thank you for purchasing this quality Heater. To ensure correct function and safety, please read all instructions before using the product and keep all instructions for future reference.



WARNING

When using electrical appliances, basic safety precautions should always be followed to reduce the risk of fire, electrical shock and personal injury.

MAIN TECHNICAL DATA

	SUNB2000BL
IP Rating:	IP65
Rated Voltage:	220 - 240V ~ 50Hz
Heater Power Input:	2000W
Dimensions:	460 x 113 x 190mm
Weight:	2.2 kg

BEFORE INSTALLATION CAUTION



IMPORTANT

**HEATER INSTALLATION AND ELECTRICAL CONNECTION MUST
BE DONE BY A LICENSED ELECTRICIAN.
THE LAMP IS NOT A REPLACEABLE ITEM**

The infrared heater is designed for safe operation. Nevertheless, installation, maintenance and operation of the heater can be dangerous. Observing the following procedures will reduce the risk of fire, electric shock, injury to persons and keep installation time to a minimum. Save these instructions for future use.

THESE INSTRUCTIONS SHOULD BE READ CAREFULLY AND RETAINED FOR FUTURE REFERENCE.

We cannot be liable for any damages caused by failure to observe these instructions.

IMPORTANT:

1. Read all instructions before using this heater.
2. Remove the unit from its packaging and check to make sure it is in good condition before using.
3. Do not let children play with packaging.

4. Check the household voltage to ensure it matches the heater's rated specification.
5. Check the power cord and plug (purchased separately) carefully before using to ensure there is no damage.
6. Before working on the electrics, be sure to turn off the power. When energising the unit, be sure your hands are dry to prevent electric shock.
7. This heater is hot when in use. To avoid burns, do not let bare skin touch hot surfaces. Keep combustible materials, such as furniture, pillows, bedding, papers, clothes, and curtains at least 3 feet (0.9 m) from the front of the heater and keep them away from the sides and rear.
8. Do not use near or in the immediate vicinity of a bath or swimming pool or any wet areas.
9. To protect against electric shock, do not immerse cord or plug in water or any other liquids.
10. Do not insert or allow foreign objects to enter any ventilation openings, as this may cause an electric shock, fire or damage to the heater.
11. Unplug the heater when not in use, if applicable.
12. Connect to properly grounded outlets only.
13. Always plug heaters directly into a wall outlet/receptacle. Never use with an extension cord or relocatable power tap (outlet/power strip).
14. Do not allow cord to overhang the counter top where it can be easily pulled by children.
15. Do not put fingers or foreign objects into the grille while in operation.
16. Do not leave the appliance unattended when in use.
17. No liability can be accepted for any damage caused by non-compliance with these instructions or any other improper use or mishandling.
18. This appliance is not intended for use by persons (including

children) with reduced physical, sensory or mental capabilities or lack of experience and knowledge unless they have been given supervision or instruction concerning the use of the appliance by a person responsible for their safety. Children and vulnerable people should be supervised to ensure they do not play with the appliance.

19. Use this heater only as described in this manual. Any other use not recommended by the manufacturer may cause fire, electric shock, or injury to persons.
20. Do not operate any heater with a damaged cord or plug or after the heater malfunctions, has been dropped or damaged in any manner. Disconnect power at service panel and have heater inspected by a reputable electrician before reusing. If the supply cord is damaged in any way, it must be replaced by the manufacturer or its service agent or a similarly qualified person in order to avoid a hazard.
21. Do not run cord under carpet. Do not cover cord with throw rugs, runners, or similar coverings. Do not route cord under furniture or appliances. Arrange cord away from traffic area and where it will not be tripped over.
22. To disconnect heater, turn controls to off, then remove plug from outlet.
23. To prevent overheating of this appliance, keep the air inlets and outlets clean and free of anything that may cause blockage. Check all inlets and outlets from time to time to ensure it is clear of any dirt or dust accumulation. **DO NOT COVER.**
24. Do not use it in areas where gasoline, paint, or flammable liquids are used or stored.
25. Parts of the heater may exceed 200°C, contact with the heating tube, reflector, or metal parts near the heating tube, may cause severe burns. To avoid burns, do not let bare skin touch hot surfaces.
26. **NEVER** place hands under the heating elements. **ALWAYS** allow heating element to cool at least 10 minutes before touching the heating tube or adjacent parts.

27. This product contains recyclable materials. Do not dispose this product as unsorted municipal waste. Please contact your local municipality for the nearest collection point.
28. The fireguard of this heater is intended to prevent direct access to heating elements and must be in place when the heater is in use.
29. The fireguard does not give full protection for young children and infirm persons.



WARNING

BEFORE INSTALLING THE HEATER, MAKE SURE YOU HAVE TURNED OFF THE MAIN ELECTRICITY SUPPLY. DO NOT TURN IT BACK ON UNTIL THE HEATER IS FULLY INSTALLED AND READY TO USE.

ALL ELECTRICAL WORK MUST BE CARRIED OUT BY A LICENSED ELECTRICIAN IN ACCORDANCE WITH THE LATEST WIRING REGULATIONS

INSTALLATION

Tools Needed:

- Pencil
- Hammer
- Level
- Screw Driver
- Power Drill and drill bits

A wall mounting bracket is provided with the heater which has been specifically designed to allow this product to be fitted to a ceiling. Before drilling, ensure the holders for the ceiling are solid and that there are no hidden water pipes or electric wires. The heater must be installed no less than **0.5m from side walls** and no less than **1.8m off the floor**.

ATTENTION! The appliance must be installed on a solid surface like concrete, wood or metal etc.

Important: Ensure that the supply cables are well mounted and that they do not come into contact with the reflector of the heater or that it does not trail into heated areas. The supply cable can be fixed to the metal mounting bracket behind the heater with plastic zip ties.

1. This heater should be installed by a qualified electrician.
2. Always disconnected the heater from the electricity supply and allow it to cool before installation.
3. For ceiling mounting, the lowest part of the heater must be located at or above a minimum height of 1.8m from ground level, so that the heater cannot be touched when in operation.
4. For ceiling mounting, there must be a 1.8m distance from your appliance to the ground.
5. When installed to the ceiling, there must be a distance of 0.5m between corners and the appliance.
6. The distance of your appliance from any objects or persons is to be min 1m.
7. The distance from the front side of the heater to materials such as wood, cloth etc., must be min 1m.
8. When mounting to a ceiling, do not position the heater at an angle more than 90 degrees.
9. The supply cable must be at the lower end of the heater if it is installed at an angle or vertically.
10. Keep the supply cord away from the body of the heater as it will get hot during use.
11. Do not install the heater on a flammable surface.
12. Observe the minimum safe distance between the heater body and the flammable surfaces when mounted.
13. The heater should always have a minimum clearance of 0.5m from a ceiling and adjacent wall.
14. If the heater is to be used outside, a weatherproof outlet is recommended.
15. Before drilling ensure that there are no wires or water pipes in the area where the heater is to be installed.
16. The heater must be installed on the mounting brackets provided.
17. Fasten the brackets securely to the mounting surface and the backside of the heater using the nuts and screws supplied.
18. Fasten the heater securely on the brackets using the nuts and bolts supplied.
19. The brackets can be used to adjust the direction of the heater, adjust the heater angle by loosening the two bolts on the wall mounting bracket, and tighten the bolts again when the desired angle is reached.
20. For bathrooms installation/s - the heater is to be installed so that switches and other controls cannot be touched by a person in the bath or shower.

WALL / CEILING INSTALLATION

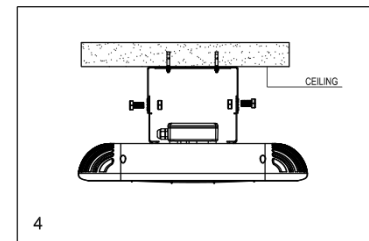
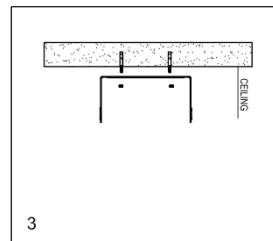
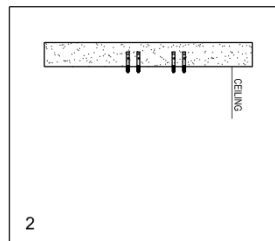
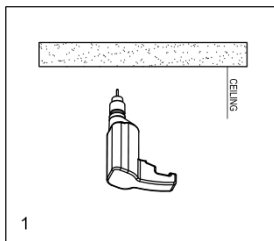
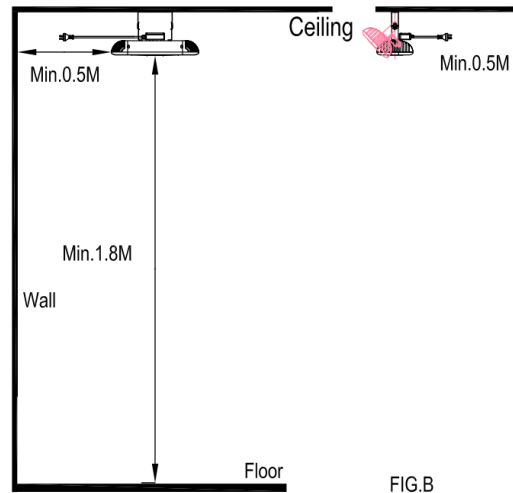
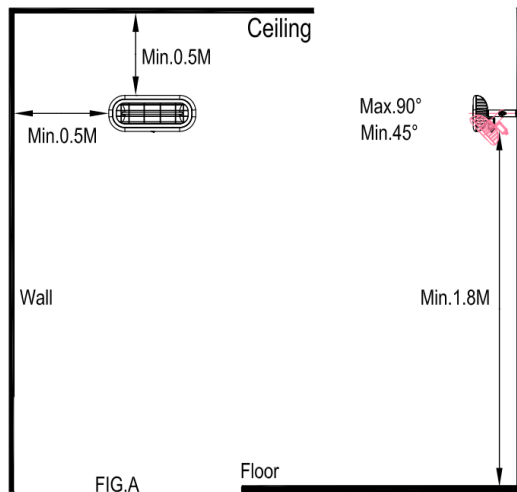

MAINTENANCE CAUTIONS



WARNING

BEFORE REPAIRING THE HEATER, MAKE SURE YOU HAVE TURNED OFF THE MAIN ELECTRICITY SUPPLY.

Caution:

When the appliance is not operated for a long period of time, cleaning or maintenance is conducted or when the location of the heater is changed, the heater should be turned to OFF and unplugged from the electrical connection. Periodic inspection and removal of dirt and contaminants will ensure that equipment can be operated safely.

1. Make sure the heater is always switched off before cleaning.
2. Check the Reflector and IR-Filament for dirt, dust or contaminants at least once a month. If necessary, apply cleaning and maintenance process.
3. The number of checks may be increased considering the amount of the dust in the environment.
4. Check the deformation of the Reflector, Wire and Frame visually while cleaning the appliance. In case of deformation, consult your technical service.
5. Check the Power Cord and Plug visually while cleaning the appliance. In case of deformation, consult your technical service.
6. Never install the heater under extreme hot environments.

CLEANING, STORAGE AND DISPOSAL

Regular and careful cleaning helps your infrared heater operate efficiently for many trouble-free years. To clean your heater, follow steps below:

1. Unplug the power cord or turn off the power for your safety before cleaning your appliance.
2. Make sure the heater is cool before continuing.
3. To keep the heater clean, the outer shell maybe cleaned with a soft, damp cloth. You may use a mild detergent if necessary. After cleaning, dry the unit with a soft cloth. (CAUTION: DO NOT let liquids enter the heater).
4. DO NOT use alcohol, gasoline, abrasive powders, furniture polish or rough brushes to clean the heater. This may cause damage or deterioration to the surface of the heater.
5. DO NOT immerse the heater in water
6. Wait until the heater is completely dry before use.

ATTENTION:

1. Always disconnect the heater from the electricity supply and allow it to cool before attempting to work on it.
2. If the heater has collected dust or dirt inside the unit or around the heating element, have the unit cleaned by a qualified service agent. Do not operate the heater in this condition.
3. The only maintenance required is cleaning of the external surfaces of the heater.
4. Do not touch the heating element with bare fingers, as residue from your hand could affect the life of the lamp. If it is accidentally touched, remove the finger marks with a soft cloth moistened with mentholated spirit or alcohol.
5. Do not attempt to repair or adjust any electrical or mechanical functions on this heater.
6. The heater contains no user serviceable parts. Should the product suffer damage or breakdown, it must be returned to the manufacturer or its service agent.
7. Damaged supply cords to be replaced by the manufacturer, service agent or similarly qualified person in order to avoid hazard.

Storage:

Store the heater in a cool, dry location when not in use to prevent dust and dirt build up. Use packaging carton to store.

If you do not plan to use the heater for extended periods of time, it is recommended that it is cleaned and stored (preferably in its original packaging) in a cool, dry place.



Do not dispose of electrical products with household waste. Please check with your local council for advice on disposal or recycling. If electrical appliances are disposed of in landfills or dumps, hazardous substances can leak into the groundwater and get into the food chain, damaging your health and well-being.

PO BOX 1285, CRAWLEY, RH10 0LY, UK

EU Authorised Representative: Anda Products Bedrijvenweg 17 7442 CX Nijverdal Nederland authorisedrep@andaproducts.nl